

# iSWM Subcommittee Task Order 4 DRAFT Documents



## **Task Order 4 Tasks**

[Task 2 – Reorganize/Re-evaluate Site Development Controls](#)

[Task 3 - Guidance on developing a regional detention program](#)

[Task 4 – Detention criteria guidance research](#)

[Task 5 – Re-evaluate 85th Percentile \(1.5”\) Rainfall Requirements](#)

[Task 6 – 5-Year Outreach and Implementation Strategy](#)

[Task 7 - Provide schematics for water quality BMPs](#)



# Bioretention

## Description

Bioretention facilities, sometimes called rain gardens or bioretention filters, are vegetated basins or landscaped areas that capture stormwater runoff and provide filtration and treatment using engineered filter media. Bioretention areas are adaptable to the needs of most site locations.

## Design Considerations

- Facilities consist of a grass filter, a sand bed, stormwater ponding area, an organic/mulch layer, planting soil, and selected landscaping for vegetation.
- The facility works on any soil group.
- Can be designed with an underdrain to send treated water into an outlet.
- Use native plants as recommended.
- Can be designed in-line or off-line.
- Requires a footprint of 5-7% of the tributary impervious area.

## Key Advantages

- They are highly effective at removing pollutants and reducing peak flow storm events for small storms.
- Bioretention areas work well in areas with a small drainage area (recommended for between 2 and 5 acres).
- Bioretention facilities can handle large amounts of impervious areas.
- Bioretention areas have relatively low maintenance requirements.
- Due to their incorporation of landscaping, bioretention facilities can be used as an aesthetic feature.

## Limitations

- Landscaping of bioretention facilities in public areas must be maintained to prevent overgrowth.
- Bioretention areas require retaining walls with steep slopes, effectively rendering them into planter boxes.
- Bioretention areas are not designed to manage peak flows from large storm events.



Bioretention Facility in San Antonio, TX. (Source: Tetra Tech)

Target Constituent	Removal Rate									
	0%	→								
Total Suspended Solids	[Progress bar showing ~90% removal]									
Total Phosphorus	[Progress bar showing ~75% removal]									
Total Nitrogen	[Progress bar showing ~60% removal]									
Fecal Coliform	insufficient data									
Heavy Metals	[Progress bar showing ~85% removal]									

## Implementation Considerations

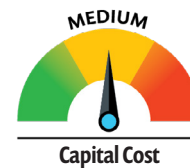

## Suitability

The iSWM manual has designated bioretention facilities as suitable for providing:



Water Quality Protection



Streambank Protection\*



On-site Flood Control\*

\*in certain situations

## Maintenance

- Trash, leaf, debris and sediment removal.
- Weeding/removing unwanted vegetation.
- Replacing dead and dying vegetation.
- Raking and replacing the top mulch layer.
- Irrigating plants after planting and during the dry season.
- Replacing soil media on an as-needed basis.
- Cleaning inlet and outlet pipes when required.
- Repairing eroded locations.



# Downspout Drywell

## Description

Downspout drywells are essentially perforated manholes that can be manufactured in a variety of sizes. This BMP is used underground and allows for infiltration even in heavily urbanized areas.

## Design Considerations

- Downspout drywells should be utilized in conjunction with pretreatment devices.
- Since infiltration is a key component of the wells, they should be used in areas with minimal risk of groundwater contamination.
- Downspout drywells are intended to be used in applications with space limitations.
- Should not be used in areas with high sediment loads to minimize clogging.
- Pervious soils (over 0.5 inches per hour) are required for the infiltration process.

## Key Advantages

- Pollutant removal can be obtained through filtration into adjacent soils.
- Peak flow rates are decreased through the use of a downspout drywell.
- Easily adaptable to the space restrictions and treatment requirements.

## Limitations

- Since downspout drywells utilize injection via a subsurface structure, special permits may be required.
- Downspout drywells should not be used in areas near drinking water wells, high groundwater tables, or areas with industrial usage.
- Maintenance may require access limitations and therefore OSHA permits.



Downspout Drywell in Traverse City, MI. (Source: Tetra Tech)

Target Constituent	Removal Rate									
	0%	10%	20%	30%	40%	50%	60%	70%	80%	100%
Total Suspended Solids										
Total Phosphorus										
Total Nitrogen										
Fecal Coliform										
Heavy Metals										

## Implementation Considerations

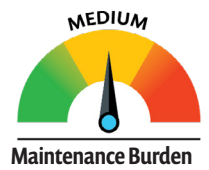

## Suitability

The iSWM manual has designated downspout drywells as suitable for providing:



Water Quality  
Protection

## Maintenance

- Clean out sediment and debris from the drywell and any pretreatment devices.
- Perform pest control if rodents, mosquitos, or other vectors are found.
- Ensure that waterlogged soils do not exist in the vicinity of the downspout drywell.
- Clear pipes when clogging occurs.



# Dry Detention/Extended Dry Detention Ponds

## Description

Dry detention ponds and extended dry detention ponds are surface storage facilities that provide detention of stormwater runoff to reduce downstream water quality impacts. They temporarily detain stormwater and gradually release it following storm events, thereby reducing the maximum runoff values associated with development. In between storm events, the facilities are typically dry.

## Design Considerations

- Dry detention ponds are designed to provide on-site flood control and can be designed to control the extreme flood event.
- Extended detention dry basins provide downstream streambank protection through detaining the streambank protection volume.
- There are no restrictions for drainage area size.
- Soil groups 'A' and 'B' may require a pond liner.
- Often used as part of a treatment train to meet water quality requirements.

## Key Advantages

- Since less excavation is required, dry detention and extended dry detention ponds are typically less costly than wet ponds for equivalent flood storage.
- Dry detention and extended dry detention ponds are often used in conjunction with water quality structural controls.
- In between storm events, there are opportunities for the facilities to be used for recreational activities.

## Limitations

- Extended dry detention ponds may provide limited water quality treatment and streambank protection.
- The area required for dry detention or extended dry detention ponds is greater than the area required for other best management practices.



Dry Detention Facility in San Antonio, TX. (Source: Halff)

Target Constituent	Removal Rate	
	0%	100%
Total Suspended Solids	[Progress bar showing ~80% removal]	
Total Phosphorus	[Progress bar showing ~60% removal]	
Total Nitrogen	[Progress bar showing ~40% removal]	
Fecal Coliform	[Progress bar showing ~85% removal]	
Heavy Metals	insufficient data	

## Implementation Considerations



## Suitability

The iSWM manual has designated dry detention ponds as suitable for providing:



Water Quality Protection



Streambank Protection



On-site Flood Control



Downstream Flood Control

## Maintenance

- Trash, leaf, debris and sediment removal.
- Provide removal of vegetation and weeds when overgrowth occurs.
- Plant seed or sod in bare or dead spots.
- Mow planted vegetation.
- Clean inlets.
- May require sediment control.



# Enhanced Swales

## Description

Enhanced swales are vegetated, open channels. They are designed to capture and treat stormwater runoff within dry or wet cells formed by check dams or other flow control devices. Enhanced swales can be wet or dry and are sometimes also called vegetated open channels or water quality swales.

## Design Considerations

- Dry swales allow the entire water quality volume to be filtered or infiltrated and are often preferred in community settings.
- Wet swales are designed to retain water and act as a linear shallow wetland system.
- Enhanced swales require relatively low slopes, typically below 4%, to prevent scour.
- Side slopes need to be relatively shallow, typically 2:1 or flatter (recommended at 4:1).
- The bottom width of the facilities can vary but is typically between 2 and 8 feet.
- The conveyance storm event must be met, including the required minimum freeboard.
- Pretreatment is recommended and typically required.

## Key Advantages

- Enhanced swales combine stormwater treatment with runoff conveyance.
- Enhanced swales are less expensive and more aesthetically pleasing than curb and gutter systems.
- Runoff velocity is reduced by enhanced swales.

## Limitations

- Enhanced swales have higher maintenance requirements than curb and gutter systems.
- Enhanced swales are not appropriate for steep slopes (longitudinal slope must be less than 4%).
- Enhanced swales may cause a resuspension of sediment.
- Due to the wet nature of the swale, there is a potential for mosquitos or other vectors, as well as for odor, if not properly maintained.
- Residential areas may not like the 4"–6" grass height.

Enhanced Swale in San Diego, CA. (Source: Tetra Tech)

Target Constituent	Removal Rate	
	0%	100%
Total Suspended Solids	[Progress bar showing ~85% removal]	
Total Phosphorus	[Progress bar showing ~40% removal]	
Total Nitrogen	[Progress bar showing ~30% removal]	
Fecal Coliform	insufficient data	
Heavy Metals	[Progress bar showing ~20% removal]	

## Implementation Considerations

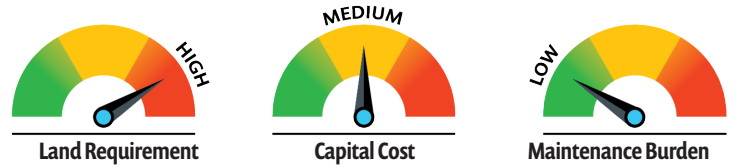

## Suitability

The iSWM manual has designated enhanced swales as suitable for providing:



## Maintenance

- Dry swales require a grass height of 4"–6", which needs to be maintained.
- Sediment accumulation should be removed from the forebay and the channel.
- Inspect for and repair erosion.
- Replant plant species if establishment does not occur.
- Trash, debris, sediment and grass clippings need to be removed.



# Filter Strip

## Description

Filter strips are land that is engineered and designed to treat runoff from and remove pollutants through vegetative filtering and infiltration. The strips are uniformly graded and densely vegetated.

## Design Considerations

- Stormwater runoff that enters a filter strip must enter via sheet flow, which requires even distribution from the adjacent impervious surface. Flow spreaders may be required.
- Best suited for treating runoff from roads, highways, roof downspouts, small parking lots, and pervious surfaces.
- A permeable berm may be included to increase contact time between runoff and the filter strip.
- Small drainage areas are required.
- Filter strips are often used as a pretreatment option for other stormwater BMPs including bioretention areas.

## Key Advantages

- Filter strips can provide pretreatment and be used as part of the runoff conveyance system.
- Groundwater recharge can be provided via filter strips.
- Filter strips have a relatively low construction cost.
- Landscaping can be performed to make filter strips aesthetically pleasing.

## Limitations

- The TSS removal target cannot be achieved by filter strips alone.
- Filter strips have a large land requirement.
- Filter strips require minimization of impacts that would lead to erosion or compaction.



Filter Strip in Asheboro, NC. (Source: Tetra Tech)

Target Constituent	Removal Rate									
	0%									
Total Suspended Solids	█	█	█	█	█	█	█	█	█	█
Total Phosphorus	█	█	█	█	█	█	█	█	█	█
Total Nitrogen	█	█	█	█	█	█	█	█	█	█
Fecal Coliform	insufficient data									
Heavy Metals	█	█	█	█	█	█	█	█	█	█

## Implementation Considerations

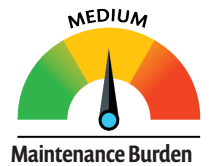

## Suitability

The iSWM manual has designated filter strips as suitable for providing:



Water Quality Protection

## Maintenance

- Grass should be maintained at 2"–4" in height.
- Periodic repair, regrading and sediment removal is required to prevent channelization.
- Rills, gullies, and other erosive spots should be remedied and repaired.
- Vegetation is required and should be replaced if not established.

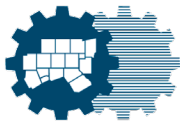

# Grass Channel

## Description

Grass channels are vegetated, open channels. They are designed to filter stormwater runoff and meet velocity targets for the water quality design storm and the streambank protection storm events. Grass channels are sometimes called biofilters. Grass channels are not the same treatment device as enhanced swales.

## Design Considerations

- Grass channels require relatively low slopes, typically below 4%. Slopes are recommended at 1–2%.
- Grass channels are most effective at low flow rates (less than 1 foot per second).
- The total suspended solids (TSS) removal is not met by grass channels alone.
- A 5-minute residence time is recommended for the water quality peak flow.
- Check dams can be utilized to increase the flow residence time and increase the treatment provided.
- Most soil types can support a grass channel, although modifications may be required if impermeable soils are found at the site.
- The bottom width of the facilities can vary but is typically between 2 and 6 feet.

## Key Advantages

- Grass channels can provide pretreatment and be used as part of the runoff conveyance system.
- If underlying soils are pervious, grass channels can partially infiltrate runoff from small storm events.
- Grass channels are less expensive than curb and gutter systems.

## Limitations

- Grass channels have higher maintenance requirements than curb and gutter systems.
- The TSS removal target cannot be achieved by grass channels alone.
- There is a potential that grass channels experience bottom erosion and a resuspension of sediment.
- Standing water may not be acceptable in some areas due to residents' concerns.



Grass Channel in Durham, NC. (Source: Tetra Tech)

Target Constituent	Removal Rate	
	0%	100%
Total Suspended Solids	[Progress bar showing ~75% removal]	
Total Phosphorus	[Progress bar showing ~50% removal]	
Total Nitrogen	[Progress bar showing ~30% removal]	
Fecal Coliform	insufficient data	
Heavy Metals	[Progress bar showing ~25% removal]	

## Implementation Considerations



## Suitability

The iSWM manual has designated grass channels as suitable for providing:



Water Quality Protection



Streambank Protection



On-site Flood Control



Downstream Flood Control

## Maintenance

- Maintain grass height at 3 to 4 inches.
- Sediment accumulation should be removed from the forebay and the channel.
- Inspect for and repair erosion.
- Replant grass species if establishment does not occur.
- Trash, debris, sediment and grass clippings need to be removed.



# Infiltration Trench and Soakage Trench

## Description

Infiltration trenches allow for the infiltration of stormwater runoff into the surrounding soils. They consist of an excavated trench filled with stone aggregate. This creates an underground reservoir for stormwater runoff. Soakage trenches are a variation of infiltration trenches and drain through a perforated pipe buried in gravel.

## Design Considerations

- Soils must have infiltration rates of 0.5 inches per hour or higher in order to effectively accept runoff.
- Geotechnical testing is required to determine infiltration rates (two borings per facility).
- Upstream treatment (such as a sediment forebay and grass channel) is required to prevent sediment choking.
- Observation wells are required in order to ensure that the facilities are functioning as designed.
- Soakage trenches are intended to be used in space-limited applications.
- Soakage trenches can be located under pavement or impervious surfaces.

## Key Advantages

- Infiltration facilities promote groundwater recharge.
- Small sites with porous soils are ideal candidates.
- Can be adapted to many types of sites due to the relatively narrow shape.
- Soakage trenches can be used in conjunction with other stormwater devices.

## Limitations

- These facilities should not be used where there is the potential for groundwater contamination.
- There is a high clogging potential due to the reliance on these facilities on infiltration. They should not be used in areas with fine-particle soils (such as clays or silts).
- Significant setback requirements are needed.
- Restrictions for infiltration in karst areas.
- The groundwater table should be below the trench area (4 feet between the bottom of the facility and the seasonally high water table).



Soakage Trench installation. (Source: Wikipedia, CC BY-SA 3.0)

Target Constituent	Removal Rate									
	0%	100%								
Total Suspended Solids	█	█	█	█	█	█	█	█	█	█
Total Phosphorus	█	█	█	█	█	█	█	█	█	█
Total Nitrogen	█	█	█	█	█	█	█	█	█	█
Fecal Coliform	█	█	█	█	█	█	█	█	█	█
Heavy Metals	█	█	█	█	█	█	█	█	█	█

## Implementation Considerations

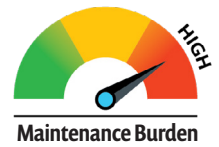

## Suitability

The iSWM manual has designated infiltration trenches and soakage trenches as suitable for providing:



Water Quality Protection



Streambank Protection

- The subsurface pipe in soakage trenches may require a special permit in some areas, as it may be considered an injection well.

## Maintenance

- Inspections to determine clogging.
- Sediment accumulation in the forebay must be removed.
- The pea gravel layer should be replaced as needed.
- Mow filter strips and remove grass cuttings.
- Trash, debris and leaves need to be removed to prevent clogging.



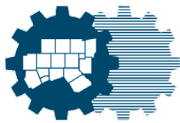

# Modular Porous Paver Systems

## Description

Modular porous paver systems are pavement surfaces composed of structural units with void areas. The void areas are filled with pervious materials such as sand or grass turf. These pavers are installed over a gravel base and underlying permeable soils. The gravel base provides storage for stormwater runoff prior to infiltration.

## Design Considerations

- Consists of structural units with void areas that are typically filled with pervious materials such as coarse sand, gravel, or turf.
- Intended for low traffic areas, or for residential or overflow parking applications.
- Soil types need to be considered—an infiltration rate of 0.5 to 3 inches/hour is required (unless an underdrain is used).
- The ratio of the contributing impervious area to the porous paver surface should be no more than 3:1.
- Slopes should be less than 5%, but preferably less than 2%.
- A minimum of 2 feet of clearance between the bottom of the gravel and the seasonally high groundwater table or underlying bedrock is required.

## Key Advantages

- Modular porous paver systems provide a reduction in runoff volume.
- There is a high level of pollutant removal with these facilities.
- Some types of systems can be purchased from commercial vendors.

## Limitations

- There are high maintenance requirements associated with modular porous paver systems.
- These systems can fail if designed incorrectly, placed in unstabilized areas, or if maintenance is not properly done.
- There is the potential for groundwater contamination with modular porous paver systems.
- Cannot be used in areas where contamination is possible (ex. industrial sites).



Modular Porous Paver System in Encinitas, CA. (Source: Tetra Tech)

Target Constituent	Removal Rate	
	0%	100%
Total Suspended Solids	not applicable	
Total Phosphorus	[Progress bar: ~80%]	
Total Nitrogen	[Progress bar: ~70%]	
Fecal Coliform	insufficient data	
Heavy Metals	[Progress bar: ~60%]	

## Implementation Considerations

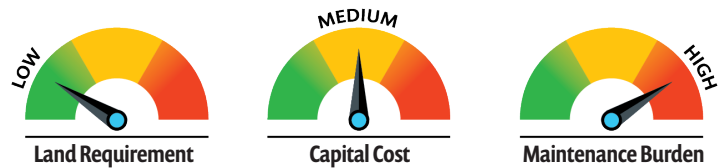

## Suitability

The iSWM manual has designated permeable pavement facilities as suitable for providing:



Water Quality Protection



Streambank Protection

## Maintenance

- Trash, leaf, debris and sediment removal.
- Vacuum or sweep the surface.
- Replace fill material as needed.
- Clear underdrain pipes of debris.
- Perform structural repairs as needed.
- Mow grass when using a permeable paver grid system.



# Planter Boxes

## Description

Planter boxes can be utilized in highly urbanized areas, especially areas with large volumes of impervious surfaces. Similar to bioretention areas, planter boxes contain vegetation and filter media to treat stormwater. Boxes can be constructed in place or pre-fabricated.

## Design Considerations

- Contained planter boxes receive only rainfall. The rainfall filters through the soil and will either be taken up by vegetation or allowed to seep out of the bottom through an underdrain. These boxes can be relocated but do not have storage for flow control.
- Infiltration planter boxes can receive both rainfall and runoff. The planters are bottomless and runoff will eventually enter the underlying soil. They should not be used next to foundations.
- Flow-through planters collect stormwater in a perforated pipe along the bottom of the box. The treated runoff is discharged out of the side of the planter or into a storm sewer. These planters must be located by a suitable discharge point.
- Planter boxes can clog and should not be used in areas with a high sediment load.
- Infiltration planter boxes must have soil types with good underlying drainage. Other planters do not have soil type restrictions.
- Water should drain through a planter within 4 hours of a storm event.
- All planters require a minimum of 18 inches of growing media.

## Key Advantages

- Filtration allows for pollutant removal.
- Planter boxes are flexible and can be used at a variety of sites.
- Planter boxes are often aesthetically pleasing.
- Peak flow rates can be limited by a reservoir.
- Planter boxes are great for urban retrofits.

## Limitations

- These facilities are intended for applications where space is limited.
- There is limited data on pollutant removal effectiveness.



Planter Box in Nashville, TN. (Source: Tetra Tech)

Target Constituent	Removal Rate	
	0%	100%
Total Suspended Solids	[Progress bar showing ~80% removal]	
Total Phosphorus	[Progress bar showing ~60% removal]	
Total Nitrogen	[Progress bar showing ~40% removal]	
Fecal Coliform	insufficient data	
Heavy Metals	[Progress bar showing ~80% removal]	

## Implementation Considerations

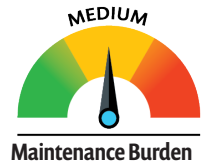
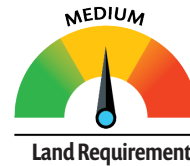

## Suitability

The iSWM manual has designated planter boxes as suitable for providing:



Water Quality Protection

## Maintenance

(See *Bioretention* for more detail)

- Frequent maintenance for vegetation and aesthetics.
- Filters may require more frequent maintenance.
- Replenish the mulch annually.
- During dry spells, the vegetation should be watered to ensure it does not die.



# Porous Concrete

## Description

Porous concrete is a specific type of Permeable Pavement that contains a mixture of coarse aggregate, Portland cement and water overlaying a stone aggregate reservoir. The mixture allows for rapid infiltration of water by providing temporary storage. Runoff infiltrates into an underdrain system or underlying permeable soils.

## Design Considerations

- Porous concrete is intended for low volume automobile traffic areas, including overflow parking areas.
- Soil types need to be considered—an infiltration rate of 0.5 to 3 inches/hour is required (unless an underdrain is installed).
- Should not be used in wellhead protection zones or recharge areas of water supply aquifer recharge zones.
- The BMP consists of an excavated area with stone media, gravel and sand filter layers, and typically includes an observation well.
- This BMP should be monitored over the entire lifespan.
- The facility should infiltrate the runoff capture volume in 24–48 hours.

## Key Advantages

- Can be used in place of traditional paved surfaces for many applications.
- Porous concrete provides a reduction in runoff volume.
- There is a high level of pollutant removal with these facilities.
- Provides ancillary benefits, such as reduced heat island effect.

## Limitations

- There are restrictions on heavy vehicle loading.
- There are high maintenance requirements associated with porous concrete.
- Design and construction may require special attention.
- The cost compared to conventional pavements is high.
- Porous concrete can fail if designed incorrectly, placed in unstabilized areas, or if maintenance is not properly performed.
- Porous concrete has the potential for groundwater contamination.
- Cannot be used in areas where contamination is possible (ex. industrial sites).



Porous Concrete in San Diego, CA. (Source: Tetra Tech)

Target Constituent	Removal Rate	
	0%	100%
Total Suspended Solids	not applicable	
Total Phosphorus	[Progress bar showing ~75% removal]	
Total Nitrogen	[Progress bar showing ~60% removal]	
Fecal Coliform	0%	
Heavy Metals	[Progress bar showing ~50% removal]	

## Implementation Considerations

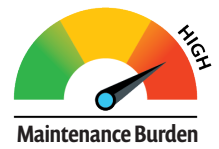

## Suitability

The iSWM manual has designated porous concrete as suitable for providing:



Water Quality Protection



Streambank Protection

## Maintenance

- Trash, leaf, debris and sediment removal.
- Vacuum or sweep the surface.
- Clear underdrain pipes of debris.
- Perform structural repairs as needed.
- Porous concrete must never be seal coated.



# Rainwater Harvesting

## Description

Rainwater harvesting (tanks or barrels) are designed to capture stormwater runoff from roofed structures. The system typically consists of a storage container, a downspout diversion, a sealed lid, and an overflow system. Rainwater harvesting may also be called rain pails, rain savers, or cisterns.

## Design Considerations

- Typical systems hold between 50 and several thousand gallons of water and may operate in series to provide additional storage volume.
- Highly applicable to residential areas.
- Screens should be considered on gutters and downspouts to remove sediment and other particles.
- First flush diverters should be added to reduce the sediment and debris loading to the rainwater harvesting device.
- Can be used in conjunction with additional BMPs as part of a treatment train system.
- Overflow mechanisms are required to prevent water from backing up in the system.

## Key Advantages

- Rainwater harvesting provides a reduction in runoff volume.
- Systems are low-cost, effective, and easy to maintain.
- Since various sizes exist, there is flexibility in the desired capture volume.
- Stormwater can be saved and reused, reducing the need for irrigation at a site. This can lead to healthier plants due to the lack of chlorination in the water.
- Rainwater harvesting systems can conserve well or municipal water during the dry season.
- Systems are available in a multitude of sizes, shapes, and materials to suit the needs of the user.

## Limitations

- Rainwater harvesting systems may have a small storage capacity.
- Some maintenance needs to be provided to the systems.
- Attention should be given to the systems after a rainfall event to prevent leaking from the system and damage to adjacent building foundations.
- Compared to the municipal water supply, the construction cost is high.
- If reuse is a possibility, roof materials need to be considered, since there is the potential for runoff contamination.



Rainwater Harvesting in Los Angeles, CA. (Source: Tetra Tech)

Target Constituent	Removal Rate	
	0%	100%
Total Suspended Solids		
Total Phosphorus		
Total Nitrogen	not applicable	
Fecal Coliform		
Heavy Metals		

## Implementation Considerations

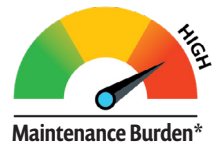

## Suitability

The iSWM manual has designated rainwater harvesting systems as suitable for providing:



Water Quality  
Protection

## Maintenance

- Check gutters and rooftops for debris that can get into the rainwater harvesting system.
- Inspect the area around the system to ensure it is not leaking and causing damage to the adjacent foundation.
- Clear the screens, first flush diverters, and system of sediment and other debris.
- Clear pipes when clogging occurs.
- Provide algae, mosquito, and other vector control when required.



# Sand Filter/Underground Sand Filter

## Description

Sand filters, also called filtration basins, are structural stormwater controls that capture and store runoff and pass it through a bed of filter sand. The facilities are multi-chamber structures that utilize a sediment forebay or sedimentation chamber, a sand bed for filter media, and often require an underdrain collection system. Sand filter designs are typically either a surface sand filter or a perimeter sand filter. Underground sand filters are a design variant that is located in an underground vault.

## Design Considerations

- Above ground facilities consist of a sand filter media with an underdrain system.
- Underground sand filters are typically used on highly impervious sites of 1 acre or less.
- Surface sand filters typically require 2 to 6 feet of head.
- The maximum drainage area for a surface sand filter is 10 acres.
- The maximum drainage area for a perimeter sand filter is 2 acres.
- The maximum drainage area for an underground sand filter is 5 acres.
- Clay or sandy soils may require a pretreatment device for above ground facilities; otherwise any soil type can be utilized.
- In order to provide water quantity control, other best management practices are required.

## Key Advantages

- Sand filters are applicable to small drainage areas.
- Highly impervious areas can be drained to sand filters for pollutant removal.
- Underground sand filters have a high pollutant removal capability.
- Sand filters have good retrofit capacity.
- Sand filters can be used in hotspot areas.
- Typically, less space is required for a sand filter than for other facilities.

## Limitations

- There are high maintenance requirements associated with sand filters (above and below ground).
- Sand filters are not recommended in areas with high sediment content loads or in clay/silt runoff areas.
- Relative to other best management practices, sand filters are relatively costly.
- There is a potential for odor problems to arise with sand filters.



Sand Filter Drain in Raleigh, NC. (Source: Tetra Tech)

Target Constituent	Removal Rate	
	0%	100%
Total Suspended Solids	[Progress bar showing ~90% removal]	
Total Phosphorus	[Progress bar showing ~75% removal]	
Total Nitrogen	[Progress bar showing ~60% removal]	
Fecal Coliform	[Progress bar showing ~85% removal]	
Heavy Metals	[Progress bar showing ~70% removal]	

## Implementation Considerations

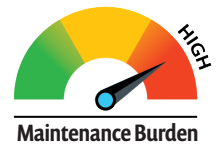
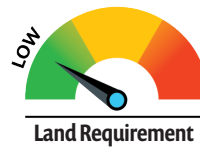

## Suitability

The iSWM manual has designated sand filters as suitable for providing:



Water Quality Protection



Streambank Protection\*

\*Above ground facilities only

## Maintenance

- Trash, leaf, debris and sediment removal.
- Provide removal of vegetation (weeds) when a surface sand filter is utilized.
- Scarify the media to promote pollutant removal.
- Clean inlets and outlets.
- Clear pipes and underdrains when required.
- Provide erosion and structural repairs when required.
- Address animal damage as needed.
- Replace media upon failure of the device.



# Stormwater Ponds

## Description

Stormwater ponds are constructed retention basins that contain a permanent pool or micropool. Stormwater runoff is detained in the ponds, and treatment is achieved through settling and biological uptake mechanisms. Stormwater ponds are also called retention ponds, wet ponds, or wet excavation detention ponds.

## Design Considerations

- Stormwater ponds are good solutions for large drainage areas. Maximum drainage areas are 25 acres, 10 acres for the micropool.
- Upstream treatment (such as a sediment forebay or equivalent) is required.
- Permanent pools should not exceed 8 feet in depth.
- Temporary storage can be provided above the permanent storage for larger storm events.
- Vegetated side slopes are required and must be no steeper than 3:1.
- Ponds located in areas with high infiltration rates will require a pond liner to keep the permanent pool.
- Ponds can require a larger area than other stormwater facilities, but can treat large areas as well.

## Key Advantages

- Urban pollutants are removed at a moderate to high rate.
- Stormwater ponds can be considered amenities and generally have a high rate of community acceptance.
- Ponds provide an opportunity for wildlife habitat.
- Stormwater ponds are among the most cost-effective facilities and are widely used.
- Multiple ponds can be used in series. The series provides improved downstream protection and longer pollutant removal pathways.

## Limitations

- High relief areas have dam height restrictions that need to be examined during design.
- Low relief terrain may cause poor drainage.
- Ponds may cause thermal impacts and downstream warming of stormwater.
- Fecal coliform removal rate decreases if waterfowl are present.
- Mosquito and other vectors may require treatment.



Stormwater Pond in San Antonio, TX. (Source: Tetra Tech)

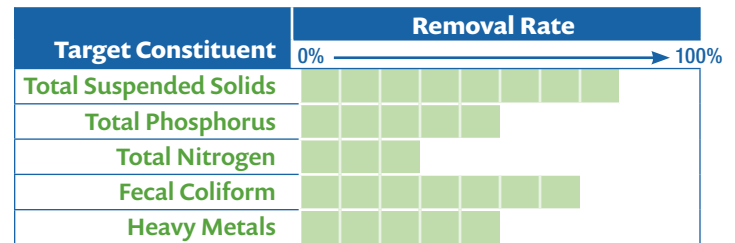

## Implementation Considerations

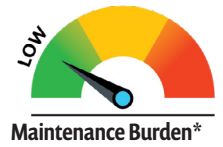

## Suitability

The iSWM manual has designated stormwater ponds as suitable for providing:



Water Quality Protection



Streambank Protection



On-site Flood Control



Downstream Flood Control\*\*

## Maintenance

- Debris needs to be removed from inlet and outlet structures.
- Invasive vegetation should be removed.
- Sediment accumulation and erosion should be monitored and remedied when issues arise.
- If dams are required, inspection and maintenance must be performed.
- Monitor for illegal dumping.
- Mosquito control and rodent repair may be required.

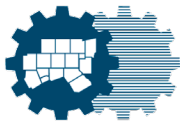

# Stormwater Wetlands

## Description

Stormwater wetland systems are constructed to hold a permanent body of water for stormwater management. Stormwater runoff volume is stored and treated within the facility. Treatment is provided by settling and uptake by marsh vegetation. These wetlands are also called constructed wetlands.

## Design Considerations

- Wetlands are designed to treat both stormwater quantity and quality.
- Variations of wetlands include shallow, extended detention (ED) shallow, pocket/wetland systems, pocket, and submerged gravel wetlands.
- Soil groups 'A' and 'B' may require a liner to keep a permanent pool elevation.
- Wetlands require a continuous base flow or high water table to support vegetation.
- Drainage area requirements are a minimum of 25 acres. Pocket wetlands have a minimum drainage area of 5 acres.
- The depth of the ponded water should vary, but 35% of the area or more should be 6" or less in depth. A deep pool (1.5 to 6 feet in depth) should encompass 10–20% of the surface area.
- Pretreatment is required to reduce the sediment load to stormwater wetlands.

## Key Advantages

- Stormwater wetlands have high levels of nutrient removal and are considered to be one of the most effective stormwater practices.
- Wetlands provide great wildlife habitat, aesthetic value, and other amenities.
- Maintenance costs are relatively low.

## Limitations

- Large land areas are required to fully implement a stormwater wetland.
- Viable wetlands require continuous base flow.
- In order to keep the wetlands viable, sediment control into the facilities is required.
- Vegetation is crucial to the success of the wetlands and must be fully established within the first three years.



Stormwater Wetland in Nashville, NC. (Source: Tetra Tech)

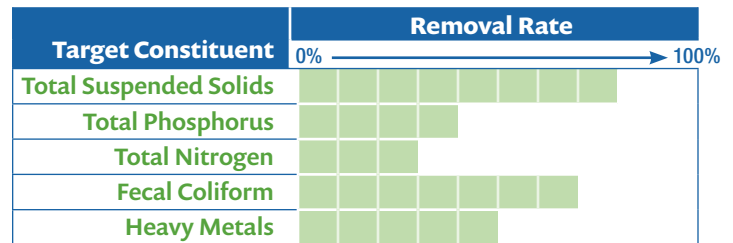

## Implementation Considerations



\*Maintenance Burden is high for a pocket wetland

## Suitability

The iSWM manual has designated stormwater wetlands as suitable for providing:



Water Quality Protection



Streambank Protection



On-site Flood Control\*\*



Downstream Flood Control\*\*

\*\*Does not apply to submerged gravel wetland systems

## Maintenance

- Wetland vegetation must be maintained and replacements should be made to maintain at least 50% surface area coverage.
- Invasive vegetation needs to be removed.
- Sediment accumulation and debris must be removed periodically (After 50% of the forebay capacity is lost).
- Eroded areas require repair.
- Algae, mosquito, and other vectors need to be controlled as issues arise.
- Rodent and other animal damage require repair.



# Underground Detention

## Description

Underground detention facilities provide water quality control through detention and temporary storage of storm water. The runoff is stored in underground vaults, pipe or tank systems. Water is gradually released following storm events. Underground detention facilities are alternatives to surface treatment.

## Design Considerations

- Underground detention facilities are often used in conjunction with a water quality structural control device.
- There are no restrictions for soil types.
- The maximum drainage area for underground detention facilities is 160 acres.
- Often used as part of a treatment train to meet water quality requirements.
- Prefabricated concrete vaults are available from commercial vendors.

## Key Advantages

- Underground facilities do not take up any surface space, which is difficult to obtain on some sites.
- Flexible design types include a concrete vault or a pipe/tank system.

## Limitations

- Underground detention facilities are not intended to provide water quality treatment.
- These facilities are intended for applications where space is limited.
- Both construction and replacement costs are high for these types of facilities.



Underground Detention Facility in Los Angeles, CA. (Source: Tetra Tech)

Target Constituent	Removal Rate									
	0%	→								
Total Suspended Solids	[Progress bar showing ~90% removal]									
Total Phosphorus	[Progress bar showing ~60% removal]									
Total Nitrogen	[Progress bar showing ~40% removal]									
Fecal Coliform	[Progress bar showing ~80% removal]									
Heavy Metals	[Progress bar showing ~50% removal]									

## Implementation Considerations



## Suitability

The iSWM manual has designated underground detention facilities as suitable for providing:



## Maintenance

- Trash, leaf, debris and sediment removal.
- Utilize a subsurface vacuum to remove pollutants and debris.
- Clean inlets and outlets.
- Clear pipes and underdrains as needed.
- Provide structural repairs when required.
- Address animal damage, including providing mosquito control.





## MEMORANDUM

---

**TO:** North Central Texas Council of Governments  
iSWM Implementation Subcommittee

**DATE:** April 2, 2021

**FROM:** Stephanie Griffin Ashley Lowrie Ben Pylant  
Halff Associates

**EMAIL:** [sgriffin@halff.com](mailto:sgriffin@halff.com) [alowrie@halff.com](mailto:alowrie@halff.com) [bpylant@halff.com](mailto:bpylant@halff.com)

**SUBJECT:** Guidance on Developing a Regional Detention Program

---

## INTRODUCTION

The North Central Texas Council of Governments (NCTCOG) integrated Stormwater Management (iSWM) subcommittee of the Public Works Council (PWC) prepared the following summary guidance on regional detention for municipalities with support from Halff Associates, Inc. Detention ponds temporarily store stormwater runoff for a designated period of time to allow the collected runoff to be safely released downstream without causing downstream damages. Regional detention options presented in this memorandum include considerations for site locations, water quality, potential funding options, and implementation. Regional detention offers unique benefits to proposed developments in that a single detention facility can accommodate detention for multiple developments and reduce the number of detention facilities overall. Many communities throughout the NCTCOG region have expressed an interest in developing a regional detention program and this guidance document is intended to help inform the process.

## CONSIDERATIONS FOR REGIONAL DETENTION LOCATIONS

Multiple factors must be considered when locating potential regional detention facilities. The natural topography and soils information are crucial to the decision-making process. The purposes of the detention basin include reducing the peak flow, controlling runoff from proposed or future development so the runoff mimics current or undeveloped flows leaving the property to the extent possible, and attenuating the peaks. The location, contributing drainage area, size, and obtainable detention volume determine the viability of potentially feasible regional detention ponds. (Halff Associates, Inc., 2011)

A detention basin is typically not effective when placed at the highest elevation within the watershed in soils that are highly porous or even dissolvable in water, such as gypsum. Thus, the pond needs to be located at the downstream end of the areas to be mitigated to best achieve this goal. Proposed developments that will contribute to the regional detention pond typically need to flow to the pond and/or be piped to the pond using gravity. The iSWM Technical Manual Site Development Controls provides additional details on siting detention ponds. (NCTCOG, 2014)

Based on the development regulations of the local jurisdiction, the regional detention basin will have to be sized to handle a particular size storm. This detention basin requires a specific area of land in order to contain the required volume and to discharge at rates allowed by the jurisdiction. The proposed location must consider potential upstream and downstream constraints, such as existing roads, culverts, railroads,

large power/utility easements, etc. All these factors must be considered prior to planning a regional detention location.

Detention facilities can be dry or wet and can incorporate open space and natural features. Dry detention basins remain dry most of the time but hold stormwater runoff during and following a storm event. Oftentimes, these areas can be multi-functional and serve as parks, trails, and sports fields, such that the development can use these areas for recreational purposes during dry weather. Wet-detention basins are always designed to hold a specific amount of water and accommodate an additional amount of stormwater runoff during and following storm events. Aerators are often incorporated in wet detention pond designs to keep the water from becoming stagnant and to reduce mosquito breeding. For iSWM purposes, only wet detention ponds receive credit for providing water quality benefits. The vegetation surrounding the pond and within the pond removes pollutants from the stormwater as it enters the pond. Sediments settle out of the stormwater in the pond. Please refer to the iSWM Construction Controls Technical Manual for more details on the benefits of wet detention ponds. (NCTCOG, 2014)



Figure 1. Laddie Place Phase III Regional Storm Water Facility resulted from a combined effort of Bexar County, the City of San Antonio and the San Antonio River Authority to convert a 28.5-acre shopping center that was almost entirely covered by impermeable surfaces except for heritage oak trees. The heritage trees are a defining feature of the former shopping mall that was converted to a regional detention facility and park with natural elements that improve the stormwater quality and increase stormwater volume.



On-channel (online) detention facilities are placed directly in the stream. Whereas off-channel (off-line) detention ponds are placed elsewhere on the site and a conveyance system is used to divert stormwater to the pond. (Harris County Flood Control District, 2020) Often, the required permitting, cost and time associated with developing an off-channel detention pond are less than an on-channel solution. Typically, runoff sheet flows into the off-channel pond or a network of pipes collects stormwater runoff from the surrounding development(s) that discharges into the off-channel detention pond. Smaller pipes or some other structure is used to control releases from the off-channel detention pond into a drainage culvert at a rate that the culvert can handle. An emergency spillway is required for on-channel and off-channel detention ponds to safely pass extreme flood flows without damaging the integrity of the structure. (NCTCOG, 2014) All local and state dam requirements must be met.

## WATER QUALITY CONSIDERATIONS ASSOCIATED WITH REGIONAL DETENTION

Native vegetation can be used to reduce the need for irrigation to maintain plant life in regional detention facilities. Vegetation filters some of the impurities from stormwater runoff, as well as within the wet pond itself. Please note that natural vegetation is also inviting to birds and animals that introduce fecal matter into the ponds, which can negatively impact water quality. The iSWM Technical Manual Site Development Controls provides additional guidance on design criteria for stormwater detention ponds that is applicable to regional detention ponds. (NCTCOG, 2014)

Erosion and sedimentation are natural processes within creeks and ponds. Erosion occurs when swift moving water picks up soil particles from the ground, banks and bottoms of creeks. Some soils erode at a faster rate than others. Erosion has the potential to negatively impact the capacity and function of regional detention facilities. Likewise, water released from the detention pond must be controlled to reduce erosion at the outfalls. The velocity flowing into and out of the detention basin needs to be slowed upon entry and exit of the facility to velocities that minimize erosion. Vegetation, such as grass and shrubbery, serve as natural forms of erosion protection. Large riprap rock and concrete baffle blocks are constructed options for controlling velocity and minimizing erosion.

The Texas Commission on Environmental Quality (TCEQ) regulates water quality for all surface waters in Texas, including regional detention facilities. Implementing iSWM features to improve stormwater quality that collects in detention ponds should meet or exceed the TCEQ criteria as set forth in the Texas Administrative Code Title 30 Chapter 307 as authorized by the Clean Water Act and Texas Water Code. (State of Texas, 2014) Water quality parameters include dissolved oxygen, temperature, pH, dissolved minerals, toxic substances, and bacteria. The purpose of the water quality regulations is to maintain the quality of surface waters in Texas that supports public health and enjoyment and protects aquatic life.

Water quality improvements resulting from regional detention are essentially the same as those described in the iSWM manual for stormwater ponds. Therefore, water quality credits should be considered for regional detention projects that incorporate water quality in the iSWM program.



## POTENTIAL FUNDING OPTIONS

Drainage facilities do not produce revenue like water and wastewater treatment facilities. Typically, drainage-related projects, including the design and construction of regional detention ponds, are funded by a community's stormwater (or drainage) utility, general budget, bond programs, and capital improvement programs (large projects). Communities have more needs than available funding, which makes funding regional detention projects difficult. Typically, regional detention facilities are intended as a proactive mitigation measure to facilitate development. Often, more pressing short-term projects are prioritized.

Public-private partnerships (P3s) can be established to fund the cost associated with large detention facilities. The partnership is an agreement between the community and the private developer to share the costs associated with the design, construction and/or operation and maintenance of the necessary detention facility. (U.S. EPA Region 3, 2015) The responsible party for O&M needs to be clearly defined. If the community is going to be responsible for the O&M, then the community needs to have a dedicated source of funding for that activity.

An often-considered source of funding for regional detention is a stormwater utility (or drainage utility) fee. Stormwater utility (SWU) fees are allowed by the Local Government Code Chapter 552 Subchapter C and provide a dedicated revenue stream to fund stormwater-related projects and activities. (State of Texas, 2009) A SWU can be used to fund the design, construction and maintenance of regional detention facilities. SWU fees are typically based on impervious area, such as parking lots, roofs, sidewalks, etc. because these are the surface types that prevent natural ground infiltration and increase runoff from a previously undisturbed site. Despite designing a detention facility to contain a 1% annual chance event, the developed site still impacts the natural runoff of the property. Several communities within the NCTCOG area provide a SWU fee credit, including Addison, Frisco and Lewisville.

Drainage impact fees are an option to communities to fund the design and construction of regional detention facilities. Drainage impact fees must follow the rules set forth in Local Government Code Title 12 Subtitle C Chapter 395. (State of Texas, 1989) A drainage impact fee may be imposed on the developer by a political subdivision to generate revenue for funding or recouping the costs of developing or expanding a detention facility. Drainage impact fees can be assessed within the limits of the political subdivision, as well as its extraterritorial jurisdiction (ETJ). The impact fee can be used to design and construct the regional detention facility but not for operation and maintenance. The fee must be assessed proportional to each of the anticipated developments who are anticipated to use the detention pond. The facility must be constructed within 10 years of collecting the fee, or the fee must be refunded.

Special districts, such as a Public Improvement District (PID), can be established as another mechanism to cover the expenses associated with regional detention facilities. PIDs can be established to finance the improvements that will benefit specific property owners within that specific district or area. A special assessment is collected from each of the properties within the district to fund the projects within the PID.

Another funding option is the establishment of a lake property owners' association, which is essentially a property owners' association with a specific focus on the regional detention pond. The lake property owners' association can establish its own bylaws and collect fees from the impacting properties to maintain the regional detention pond. The property owners' association should be incorporated, and an agreement should define the required maintenance and associated expenses attributed to each of the impacted property owners. No agency regulates property owners' associations. Therefore, any disagreement that



might arise between a property owner and the association is beyond the Texas Secretary of State's authority and would be left to the private parties to resolve with their own attorneys and at their own expense. (Texas Secretary of State, 2020)

This list of potential funding opportunities presented is not exhaustive. These funding ideas are the most common funding options for regional detention ponds. Other funding options may be available to the local jurisdictions and should be considered as appropriate.

## IMPLEMENTATION OF REGIONAL DETENTION PROGRAM

The regional detention facility may be owned, operated and maintained by a private entity or the local jurisdiction. In either case, the ownership and maintenance responsibilities associated with the facility should be identified in a legal agreement. At a minimum, the pond should be inspected quarterly. An annual pond inspection report should be prepared by the responsible entity and submitted to the local jurisdiction. Any deficiencies found in the regular inspections and the resolution of each should be included in the annual report.

When the water velocity slows, the sediment falls out of the water flow and settles to the bottom of the pond. The settled deposits of soil particles build up over time and are referred to as sedimentation. The sedimentation needs to be removed periodically to maintain the effective volume of the detention basin. The frequency required for sedimentation removal, or dredging, depends on the rate of buildup within the pond. Ponds should be designed to accommodate a certain rate of sedimentation to reduce the frequency of necessary dredging activity. Stilling basins with permanent access ramps could be added upstream of the detention pond to collect sediment for easier removal. Dredging activities may require a National Pollution Discharge Elimination System (NPDES) stormwater permit.

Local jurisdictions typically do not have the staff to perform regular inspections or funding to pay for necessary maintenance and repairs to regional detention ponds. The local jurisdiction should consider requiring a Pond Operation and Maintenance (O&M) agreement with the property owner. The O&M agreement should clearly state the roles and responsibilities of each party. The document should be filed with the appropriate county for the respective property. This approach reduces the chances of the local jurisdiction receiving the O&M responsibilities as a result of the property owner deeding the pond to the jurisdiction without the jurisdiction's knowledge. An example of what this agreement document could look like is provided in Appendix A. This template is based on agreement documents utilized by the City of Fort Worth and the City of Grand Prairie.

## ADDITIONAL CONSIDERATIONS

Local community land use planning and zoning regulations should reflect the FEMA minimum or higher standards with regards to development in and around floodplains. These local regulations naturally provide open space within a floodplain area that may be suitable for conversion to regional detention. If such an approach is not feasible, then the regional detention should be placed outside the floodplain and be designed to work with the natural flows within the floodplain.

Regional detention facilities may be considered dams. A dam is defined by the Texas Administrative Code Title 30 Part 1 Chapter 299 Subchapter A as being "any barrier or barriers, with any appurtenant structures,



constructed for the purpose of either permanently or temporarily impounding water.” (State of Texas, 2009) Any dam that has a height greater than or equal to 25 feet and a maximum storage capacity greater than or equal to 15 acre-feet or has a height greater than six feet and a maximum storage capacity greater than or equal to 50 acre-feet is required to adhere to the TCEQ dam requirements. The Texas Commission on Environmental Quality (TCEQ) requires that all dams that impound water have a water rights permit. TCEQ requires dams to be designed to handle the probable maximum flood (PMF) and the 1% annual chance flood event.

When considering the appropriate size and location for a regional detention facility, the property downstream and its potential use should be considered. While the property may be vacant now, the future land use plan may show that the property is anticipated to become residential development(s) and change the dam classification to high hazard. High hazard dams have additional operation and maintenance responsibilities that must be considered and included in the development. Ultimate development or ultimate land use should be used as the basis for sizing regional detention ponds. (Halff Associates, Inc., December 2014) The ultimate land use impacts the manner and speed at which runoff moves across the development, which in turn impacts the size and location for the pond.

A best management practice, if not already required by the state or local jurisdiction, includes having an emergency action plan for potential issues with the dam or impoundment holding the stormwater in the detention pond. TCEQ’s Guidelines for Developing Emergency Action Plans for Dams in Texas provides details on which dams are required to have emergency action plans and the specific information that must be included in those plans. (TCEQ, December 2019) The emergency action plan should identify the area that would likely be damaged in the event of a dam failure. The plan should also include the actions to be taken and the department or personnel who are responsible for implementing the plan.

The United States Army Corps of Engineers (USACE) must be consulted if the location of the proposed detention facility is planned for an area that may contain wetlands, thus requiring a Section 404 permit. Impacted wetlands are required to be mitigated. Ideally, the detention pond should be located to avoid wetlands. When wetlands cannot be avoided, the developer should plan for a lengthy and potentially costly permitting process.

Regional detention is intended to reduce flood risk up to a specified storm design size. The reduced flood risk benefits the proposed development within the project area and downstream of the detention pond discharge point. The runoff from the proposed development will collect in the detention pond and be discharged at a rate such that it does not increase the flow in the creek above what the creek received prior to the proposed development. Therefore, the flood risk to properties downstream should remain unchanged up to the design storm of the detention pond. As with any detention facility, flood risks still exist with regional detention ponds. (Halff Associates, Inc., December 2014) Storms may exceed the capacity of the facility’s design. If development plans change, the potential flooding may also change or may require modifications to a regional detention pond to accommodate the increased flows.



## REFERENCES

- Halff Associates, Inc. (December 2002). *City of Richardson, Urban Lake Study Final Report*. Capital Projects/Engineering. Richardson, TX: Halff Associates, Inc.
- Halff Associates, Inc. (December 2014). *Cottonwood Creek Headwaters Detention Feasibility Study Final Report*. Richardson, TX: Halff Associates, Inc.
- Halff Associates, Inc. (July 2011). *City of Balch Springs Hickory Creek Flood Protection Planning Study Final Report*. Richardson, TX: Halff Associates, Inc.
- Harris County Flood Control District. (2020, December 3). *Stormwater Detention: How It Works*. Retrieved from Harris County Flood Control District: <https://www.hcfd.org/Additional-Resources/Flooding-and-Floodplains/Stormwater-Detention-How-it-Works>
- NCTCOG. (2014, September). *integrated Stormwater Management Technical Manual; Site Development Controls*. Retrieved from North Central Texas Council of Governments: <http://iswm.nctcog.org/technical-manual.html>
- State of Texas. (1989, August 28). *Title 12, Subtitle C, Chapter 395, Subchapter B. Authorization of Impact Fee*. Retrieved from Local Government Code: <https://statutes.capitol.texas.gov/Docs/LG/htm/LG.395.htm>
- State of Texas. (2009, April 1). *Title 13, Subtitle A, Chapter 552, Subchapter C. Municipal Drainage Utility Systems*. Retrieved from Local Government Code: <https://statutes.capitol.texas.gov/Docs/LG/htm/LG.552.htm#C>
- State of Texas. (2009, January 1). *Title 30 Part 1 Chapter 299 Dams and Reservoirs*. Retrieved from Texas Administrative Code: [https://texreg.sos.state.tx.us/public/readtac\\$ext.ViewTAC?tac\\_view=5&ti=30&pt=1&ch=299&sch=A&rl=Y](https://texreg.sos.state.tx.us/public/readtac$ext.ViewTAC?tac_view=5&ti=30&pt=1&ch=299&sch=A&rl=Y)
- State of Texas. (2014, March 6). *Title 30 Part 1 Chapter 307 Texas Surface Water Quality Standards*. Retrieved from Texas Administrative Code: [https://texreg.sos.state.tx.us/public/readtac%24ext.ViewTAC?tac\\_view=4&ti=30&pt=1&ch=307&rl=Y](https://texreg.sos.state.tx.us/public/readtac%24ext.ViewTAC?tac_view=4&ti=30&pt=1&ch=307&rl=Y)
- TCEQ. (December 2019, December). *Guidelines for Developing Emergency Action Plans in Texas*. Dam Safety Program, Critical Infrastructure Division. Austin, TX: Texas Commission on Environmental Quality. Retrieved from Texas Commission on Environmental Quality: [https://www.tceq.texas.gov/assets/public/comm\\_exec/pubs/gi/gi-394.pdf](https://www.tceq.texas.gov/assets/public/comm_exec/pubs/gi/gi-394.pdf)
- Texas Secretary of State. (2020). *Home or Property Owners' Association FAQs*. Retrieved December 4, 2020, from Texas Secretary of State Ruth R. Hughes: <https://www.sos.state.tx.us/corp/hpoafaqs.shtml>
- U.S. EPA Region 3. (2015). *Community Based Public-Private Partnerships (CBP3s) and Alternative Market-Based Tools for Integrated Green Stormwater Infrastructure; A Guide for Local Governments*. Water Protection Division. Washington, D.C.: U.S. EPA Region 3. Retrieved from [https://www.epa.gov/sites/production/files/2015-12/documents/gi\\_cb\\_p3\\_guide\\_epa\\_r3\\_final\\_042115\\_508.pdf](https://www.epa.gov/sites/production/files/2015-12/documents/gi_cb_p3_guide_epa_r3_final_042115_508.pdf)



## APPENDIX A

---



NOTICE OF CONFIDENTIALITY RIGHTS: IF YOU ARE A NATURAL PERSON, YOU MAY REMOVE OR STRIKE ANY OR ALL OF THE FOLLOWING INFORMATION FROM ANY INSTRUMENT THAT TRANSFERS AN INTEREST IN REAL PROPERTY BEFORE IT IS FILED FOR RECORD IN THE PUBLIC RECORDS: YOUR SOCIAL SECURITY NUMBER OR YOUR DRIVER'S LICENSE NUMBER.

## Landowner/Developer Inspection and Maintenance Agreement

STATE OF TEXAS

**KNOW ALL PERSONS BY THESE PRESENTS**

COUNTY OF \_\_\_\_\_

THIS AGREEMENT, made and entered into this \_\_\_\_\_ day of \_\_\_\_\_, 20\_\_\_\_\_, by and between \_\_\_\_\_, hereinafter called the "Landowner," whose address is \_\_\_\_\_, and the City (or County) of \_\_\_\_\_, Texas, whose address is \_\_\_\_\_, hereinafter called the "City" (or "County").

WITNESSETH, that:

WHEREAS, the Landowner is the owner of certain real property described as an approximately \_\_\_\_\_ acre tract located in the \_\_\_\_\_ Survey, Abstract No. \_\_\_\_\_ as recorded by deed recorded in Volume \_\_\_\_\_, Page \_\_\_\_\_, dated \_\_\_\_\_ in the Public Official Records of \_\_\_\_\_ County, Texas, Instrument Number \_\_\_\_\_, hereinafter the "Property"; and

WHEREAS, the Landowner is proceeding to build on and develop the Property; and

WHEREAS, the Site Plan/Subdivision Plan known as \_\_\_\_\_, City (or County) File No. \_\_\_\_\_ hereinafter called the "Plan", which is incorporated herein by reference, as approved or to be approved by the City (or County), provides for stormwater management facilities within the confines of the Property; and

WHEREAS, the City (or County) and the Landowner, its successors, assigns and heirs in interest, including any Homeowners Association (HOAs) or Planned Improvement District (PID) agree that the health, safety, and welfare of the residents of \_\_\_\_\_, Texas require that on-site stormwater management facilities be constructed and maintained on or under the Property; and

WHEREAS, the City requires that on-site stormwater management facilities as shown on the Plan be constructed and adequately maintained by the Landowner, its successors and assigns, the location and dimensions of which is shown and more particularly described by metes and bounds in the attached Exhibit "A" ("Facility Property"), and

NOW, THEREFORE, in consideration of the foregoing premises, the mutual covenants contained herein, and the following terms and conditions, the parties hereto agree as follows:

1. That the on-site stormwater management facilities shall be constructed by the Landowner in accordance with the plans and specifications contained in City (Or County) File No. \_\_\_\_\_ of the Plan.
2. That Landowner shall adequately maintain the stormwater management facilities. This includes all pipes and channels on or under the Property built to convey stormwater to the facility, as well as all structures, improvements, and vegetation on or under the Property provided to control the quantity and quality of the stormwater. Adequate maintenance is herein defined as good working condition so that these facilities are performing their design functions.
3. That Landowner shall inspect the stormwater management facility and submit an inspection report annually. The purpose of the inspection is to assure safe and proper functioning of the facilities. The inspection shall cover the entire facilities, and deficiencies shall be noted in the inspection report.
4. That Landowner hereby grants permission to the City (or County), its authorized agents and employees, to enter upon the Property and to inspect the stormwater management facilities whenever the City (or County) deems necessary. The purpose of inspection is to follow-up on reported deficiencies and/or to respond to citizen complaints. Except in the case of emergency, and to the extent Landowner has provided the City (or County) with its contact information (email or telephone number), the City (or County) may, but is not required to, provide prior notice to the Landowner of an inspection. The City (or County) shall provide the Landowner copies of the inspection findings and a directive to commence with the repairs if necessary.
5. That in the event the Landowner fails to maintain the stormwater management facilities in good working condition acceptable to the City (or County), and fails to correct such condition(s) within the time designated by the City (or County), the City (or County) may enter upon the Property and take whatever steps necessary to correct deficiencies identified in the inspection report and to charge the costs of such repairs to the Landowner. This provision shall not be construed to allow the City (or County) to erect any structure of permanent nature on the land of the Landowner that is different from or in addition to the facilities described in the Plan or outside of the easement for the stormwater management facilities. It is expressly understood and agreed that the City (or County) is under no obligation to routinely maintain or repair said facilities, and in no event shall this Agreement be construed to impose any such obligation on the City (or County).
6. That Landowner shall perform the work necessary to keep these facilities in good working order as appropriate. In the event a maintenance schedule for the stormwater management facilities (including sediment removal) is outlined on the approved plans, the schedule shall be followed.
7. That in the event the City (or County) pursuant to this Agreement, performs work of any nature, or expends any funds in performance of said work for labor, use of equipment, supplies, materials, and the like, the Landowner shall reimburse the City (or County) within ten (10) days after demand for all costs reasonably incurred.
8. That this Agreement imposes no liability of any kind whatsoever on the City (or County) and the Landowner agrees to hold the City (or County) harmless for the design, construction, operation, maintenance or use of any stormwater management facility to be developed, constructed or used

by the Landowner or its successor, assigns or heirs. The Landowners shall indemnify and hold harmless the City, its officers, employees, and agents from any direct or indirect loss, damage, liability, or expense and attorney's fees for any negligence of the Landowner, his contractors, engineers, agents, or representatives, arising out of the design, construction, or condition of the stormwater management facility or the Landowner's operation, maintenance, or use of the stormwater management facility including any non-performance of the foregoing. Any successor landowner of the Property shall have full responsibility and liability for the stormwater management facility as herein described. All the above shall be covenants running with the land.

9. Landowner covenants and agrees that no habitable building shall be erected within the drainage easement outlined on Exhibit "A" but this paragraph shall not preclude construction of other improvements within the drainage easement, which do not impede drainage. Landowner covenants and agrees that no habitable building shall be erected on the above property abutting such easement which shall have a finished floor at an elevation less than two feet above the maximum depth of water in the detention pond which would occur during a 100 year frequency flood.
10. This Agreement shall be recorded among the land records of \_\_\_\_\_ County, Texas, shall constitute a covenant running with the land, and shall be binding on the Landowner, its administrators, executors, assigns, heirs and any other successors in interests, including any property owner's association.

WITNESS the following signatures and seals:

Executed this \_\_\_\_\_ day of \_\_\_\_\_ 20\_\_\_\_\_.

LANDOWNER:

CITY (or COUNTY OF \_\_\_\_\_, TEXAS

BY: \_\_\_\_\_

By: \_\_\_\_\_

City (or County) Official

CONTACT INFORMATION FOR LANDOWNER:

ATTEST:

Email Address: \_\_\_\_\_

\_\_\_\_\_

Phone Number: \_\_\_\_\_

City Secretary

APPROVED AS TO FORM:

\_\_\_\_\_

City (or County) Attorney

STATE OF TEXAS

COUNTY OF \_\_\_\_\_

This instrument was acknowledged before me on the \_\_\_\_ day of \_\_\_\_\_, 20\_\_\_\_\_, by \_\_\_\_\_, on behalf of City (or County) of \_\_\_\_\_ in the capacity herein noted and for the purposes stated.

\_\_\_\_\_  
Notary Public in and for the State of Texas

STATE OF TEXAS

COUNTY OF \_\_\_\_\_

Before me, the undersigned authority on this \_\_\_\_ day of \_\_\_\_\_, 20\_\_, personally appeared \_\_\_\_\_, known to me to be the person whose name is subscribed to the foregoing instrument and acknowledged to me that the same is the act of \_\_\_\_\_, and that he executed the same as its \_\_\_\_\_ and as the act of such \_\_\_\_\_ and for the purposes and consideration expressed in the foregoing instrument.

\_\_\_\_\_  
Notary Public in and for the State of Texas

**EXHIBIT "A"**

INSERT LEGAL DESCRIPTION





Due to the uncertainty of the effectiveness or lack of effectiveness of this standard of practice it is evident that many cities are either modifying the criteria to other alternatives that attempt to further limit the duration and frequency of channel altering flows. There are some examples nationally where a 2-year over control method is required. This method requires the storage of the 2-year 24-hour storm event with controlled release that does not exceed 50% of the predevelopment peak discharge. This generally increases the required storage footprint considerably and has mostly only been attempted in northern municipalities with vastly different hydrologic conditions than those found in Texas.

The most common practice identified in our research aside from the 2-year, 24-hour, pre-development peak flow control is the requirement for extended detention of the 1-year, 24-hour storm event with a maximum drawdown time of 24 hours. The volume required for this practice is generally similar to the volume required to manage the peak discharges from 5 to 10-year storm events. This practice generally reduces the frequency, duration, and intensity of channel altering flows but there is a trade off in the area required and there are challenges with the sizing of 1-year discharge controls that tend to be smaller and more susceptible to clogging. It should also be noted that the effectiveness of this design criteria is again largely dependent on the physical bed and bank materials and state of aggradation or degradation of the receiving stream.

The emerging strategy for stream bank protection is distributed runoff control. This strategy requires highly localized detail of the erosive potential of the receiving streams throughout the entire reach. Many municipalities and agencies have begun or completed the lengthy process of further collecting data on ephemeral, perennial, and riverine systems throughout their jurisdiction and enhancing the downstream assessment process with a clearer understanding of allowable duration and intensities of flows that vary greatly within the stream network. The vast majority of the research and development in this area is grounded on the processes developed for the [Rosgen Stream Classification system \(EPA\)](#) coupled with the development of dynamic hydraulic models for stream networks that facilitate the design process and ultimately the selection of optimized storage and discharge controls specific to the sub-watershed and receiving stream characteristics.

Based on our research it appears that in the absence of detailed stream system data including but not limited to dynamic hydraulic models, bed and bank material assessment, degradation and aggradation state documentation, that the current recommended process in the iSWM criteria manual to manage and control the release of the 1-yr, 24-hour storm event is appropriate. The trade-off is that this will likely require a larger storage footprint and that there are challenges in designing efficient outflow structures that aren't susceptible to clogging. This process combined with the requirements of the downstream assessment appears to be the most prudent approach for minimizing erosion and sedimentation impacts within stream systems in North Texas. In locations where there is substantial stream system data and dynamic hydraulic models it is recommended that a flexible approach to determination of allowable discharges should be utilized. This appears to be the direction that the City of Austin is moving toward while maintaining a standard approach of requiring the storage and controlled release of the 2-year, 24-hour storm event. The challenge of utilizing the option to fine tune storage and discharge requirements appears to fall back on the developer and designer capacity to utilize available hydraulic models and have a deep understanding of stream channel stability. Shifting to the 2-year, 24-hour storm event may offer some flexibility in the overall footprint requirements for detention storage, but unless it is combined with



detailed knowledge of stream hydraulic and bed and bank material conditions it is not likely to provide for more stable conditions than what is provided by current guidance.

## SUMMARY OF PRACTICES

City of Austin:

Requires management of the 2-year, 24-hour storm with peak discharges equal to pre-development conditions. Allows for modified approaches based on standards outlined in erosion hazard guidance and utilization of stream conditions data and models. Proposed modifications to the city's development criteria re-write

'CodeNext' indicates that they will change the wording from requiring management of the 2-year, 24-hour storm to the stream protection volume to allow for more flexibility and efficiencies in the design of detention ponds. It's also important to note that the City provides guidance in terms of Storm Water Management ponds and does not have separate guidance for dry and wet detention ponds related to volume storage and discharge.

[https://www.austintexas.gov/sites/default/files/files/Watershed/erosion/EHZ\\_Criteria\\_2013\\_Q3.pdf](https://www.austintexas.gov/sites/default/files/files/Watershed/erosion/EHZ_Criteria_2013_Q3.pdf)

<http://www.austintexas.gov/edims/document.cfm?id=293134>

[https://library.municode.com/tx/austin/codes/drainage\\_criteria\\_manual?nodeId=S8STMA](https://library.municode.com/tx/austin/codes/drainage_criteria_manual?nodeId=S8STMA)

City of San Antonio:

The City of San Antonio does not have criteria for streambank protection volume management. The City of San Antonio restricts the outflow rates to the undeveloped or existing five (5) year, twenty-five (25) year, and one hundred (100) year frequencies, 24-hour storm and allows drawdown time of 48 or 24-hours.

<http://www.sanantonio.gov/Portals/0/Files/CIMS/Services/cosa-final-swdcm-jan-2016-web-version.pdf>

City of Fayetteville:

Within Fayetteville they must provide extended detention of the increased volume of the 1-year storm event released over a period of 40 hours to reduce flows and protect downstream channels from erosive velocities and unstable conditions. Post-development flows shall not exceed the predevelopment flows.

<https://www.fayetteville-ar.gov/DocumentCenter/View/2248/Drainage-Criteria-Manual-2014-PDF>

City of Tulsa:

The outlet shall be designed to provide discharges from the pond that are equal to or less than predevelopment discharges for the 100% (1-year), 50% (2-year), 20% (5-year), 10% (10-year), 2% (50-year), and 1% (100-year) flood events. Orifice or slotted weir configurations should be as large as possible to meet the design requirements. The computed channel velocities in natural channels, along with the computed Froude Number, should be used to determine the necessity of channel protection from erosion. Channel velocities should not be increased due to the design of a project.

<https://www.cityoftulsa.org/media/11859/stormwatermanagementcriteriamanual-june2019.pdf>

City of Little Rock:





Volume for storage and discharge requirements are based only on the differential runoff from post development and predevelopment conditions for the 25-year, 6-hour storm event. There are now requirements for managing the stream protection volume.

[https://www.littlerock.gov/media/1495/stormwater\\_drain-man-update-09-2016.pdf](https://www.littlerock.gov/media/1495/stormwater_drain-man-update-09-2016.pdf)

Harris County:

The outflow structure must be sized for water quality enhancement to detain the extended detention component of the water quality volume for a minimum of 24-hours. The extended detention volume is either: equal to 50% of the water quality volume where the remaining 50% of the water quality volume is allocated to the permanent pool (EPA 1999a); or equal to an optimum percentage where the additional water quality volume is assigned to the permanent pool using the design engineer's best professional judgment.

[https://acechouston.org/wp-content/uploads/2018/04/PCPM-Update\\_ACEC-SW-Comm-Revision-Draft-129-2018.pd](https://acechouston.org/wp-content/uploads/2018/04/PCPM-Update_ACEC-SW-Comm-Revision-Draft-129-2018.pd)

SUPPLEMENTAL INFORMATION: 2018 EPA Document: "Detention Outlet Retrofit Improves The Functionality of Existing Detention Basins By Reducing Erosive Flows in Receiving Channels"

<https://www.ncbi.nlm.nih.gov/pmc/articles/PMC6171122/pdf/nihms-1503928.pdf>



## MEMORANDUM

**TO:** North Central Texas Council of Governments  
iSWM Implementation Subcommittee

**DATE:** April 12, 2021

**FROM:** Sam Sarkar, PE  
Tetra Tech

Ashley Lowrie, PE, CFM  
Halff Associates

Ben Pylant, PE, CFM  
Halff Associates

**EMAIL:** [sam.sarkar@tetrattech.com](mailto:sam.sarkar@tetrattech.com) [alowrie@halff.com](mailto:alowrie@halff.com) [bpylant@halff.com](mailto:bpylant@halff.com)

**SUBJECT:** Re-evaluate 85th Percentile Rainfall Requirements (DRAFT)

### INTRODUCTION

The North Central Council of Governments (NCTCOG) Integrated Stormwater Management (iSWM) Technical Manual on Water Quality, based on a rainfall analysis, identifies 1.5-inches as the average depth of rainfall associated with the 85th-percentile storm for the NCTCOG region. The iSWM Technical Manual recommends complete capture of the runoff generated by the 85th-percentile storm as the basis for design of stormwater management systems to treat water quality and a minimum detention period of 24-hours. The volumetric runoff coefficient (RV) and the water quality protection volume (WQV) associated with the 85th-percentile storm are calculated using equations (1) and (2) shown below. In inches, WQV may be expressed using equation (3).

$$R_V = 0.05 + 0.009 * I \quad (1)$$

where,

$R_V$  = volumetric runoff coefficient

$I$  = percent impervious cover (%)

$$WQ_V = \frac{1.5 * R_V * A}{12} \quad (2)$$

where,

WQV = water quality protection volume (acre-feet)

$R_V$  = volumetric runoff coefficient

$A$  = drainage area (acres)

$$Q_{WV} = 1.5 * R_V \quad (3)$$

where,

QWV = water quality protection volume (inches)

The purpose of this task is to re-evaluate the 85th-percentile storm runoff capture as stipulated in the iSWM Technical Manual. Specifically, long-term rainfall hourly data at National Climactic Data Center (NCDC) stations in the NCTCOG region were analyzed using the Urban Watersheds Research Institute (UWRI) Water Quality Capture Optimization and Statistics Model (WQ-COSM)<sup>1</sup>.

<sup>1</sup> <https://www.uwtrshd.com/downloads/water-quality-capture-optimization-statistical-model-wq-cosm>

## METHODS

The methods used by WQ-COSM to determine the water quality capture volume (WQCV) basin size using WQ-COSM are summarized below.

1. WQ-COSM uses continuous sub-daily rainfall data to identify individual storms based on a user-specified inter-event dry period. The program subsequently screens out small user-specified non-runoff producing rainfall events and large outlier storms prior to calculating runoff.
2. The filtered rainfall data is used to calculate continuous runoff at each time increment. Runoff may be calculated using the Rational, Horton or Green-Ampt methods.
3. Conducts a simple mass balance of runoff volume and number of storms captured based on a range of increasing WQCV basin size and user-specified time to empty WQCV basin.
4. Reports optimal WQCV basin size based on the “point of diminishing return” determined from plots of runoff volume and number of storm events captured against a range of WQCV basin sizes.

The Tarrant Regional Water District (TRWD) recently revised the estimates for water quality volume (WQV) using a continuous hydrology simulation model. While the runoff capture is still based on the 85<sup>th</sup>-percentile storm event, the WQV accounts for basin drain time. No other similar methodologies were found in Texas at this time.

The input parameters required by WQ-COSM are shown in Figure 1. The ranges of input parameters recommended by the developers of WQ-COSM are summarized in Table 1.

Table 1. Recommended Ranges for WQ-COSM Input Parameters.

Parameter Name	Recommended Range		Default Values	Units
	Min	Max		
Dry Period Separation for New Storm	6	12	6	hours
Minimum Storm Depth Needed for Runoff	0.06	0.12	0.08	inches
WQCV Basin Emptying Time	12	96	40	hours
Drying Period	3	7	5	days

## Input Parameters Summary Sheet

WQ-COSM v3.1.01 (January 2020)

<i>Project I.D. and Rainfall Processing Parameters</i>				
NOAA Precipitation Data Filepath & Name:				
Precipitation Data Station Name:				
Project/Study Location:				
Dry Period Separation for New Storm:	6	hours	NOAA Precipitation Unit Time:	
Minimum Storm Depth Needed for Runoff:	0.08	in		60 min
<i>WQCV Basin Sizing Parameter</i>				
WQCV Basin Emptying Time:	24	hours		
<i>Runoff Processing Parameters</i>				
Catchment Imperviousness:	100%			
(At least one imperviousness value required, others are optional)				
Storm Runoff Outlier Exclusion (Upper % Outlier):	99.5%			
Drying Period:	3	days		
Runoff Model:	Rational Method ▼			
<b>Horton</b>				
Initial Infiltration Rate:	n/a	in/hr		
Final Infiltration Rate:	n/a	in/hr		
Infiltration Decay Coefficient:	n/a	1/hr		
Pervious Depression Storage:	n/a	in		
Impervious Depression Storage:	n/a	in		
<b>Green Ampt</b>				
Average Capillary Suction:	n/a	in		
Saturated Conductivity:	n/a	in/hr		
Maximum Soil Moisture Deficit:	n/a	in/in		
Pervious Depression Storage:	n/a	in		
Impervious Depression Storage:	n/a	in		
<b>Rational Method</b>				
Recommended Runoff Coefficients:	0.886			
User Override Runoff Coefficients:	0.900			

Figure 1. WQ-COSM Input Parameters.

WQ-COSM was used to determine optimal WQCV basin size for all National Climactic Data Center (NCDC) stations with at least 30-years of hourly precipitation data in the NCTCOG region (Figure 2). Default values (Table 1) were used for dry period separation for new storms, minimum storm depth needed for runoff, WQCV basin emptying time and drying period. Catchment imperviousness was assumed at 100%. Continuous hourly rainfall data for the stations shown in Figure 2 were downloaded from the National Centers for Environmental Information (NCEI) Climate Data Online Map Server (<https://gis.ncdc.noaa.gov/maps/ncei/cdo/hourly?layers=001>).

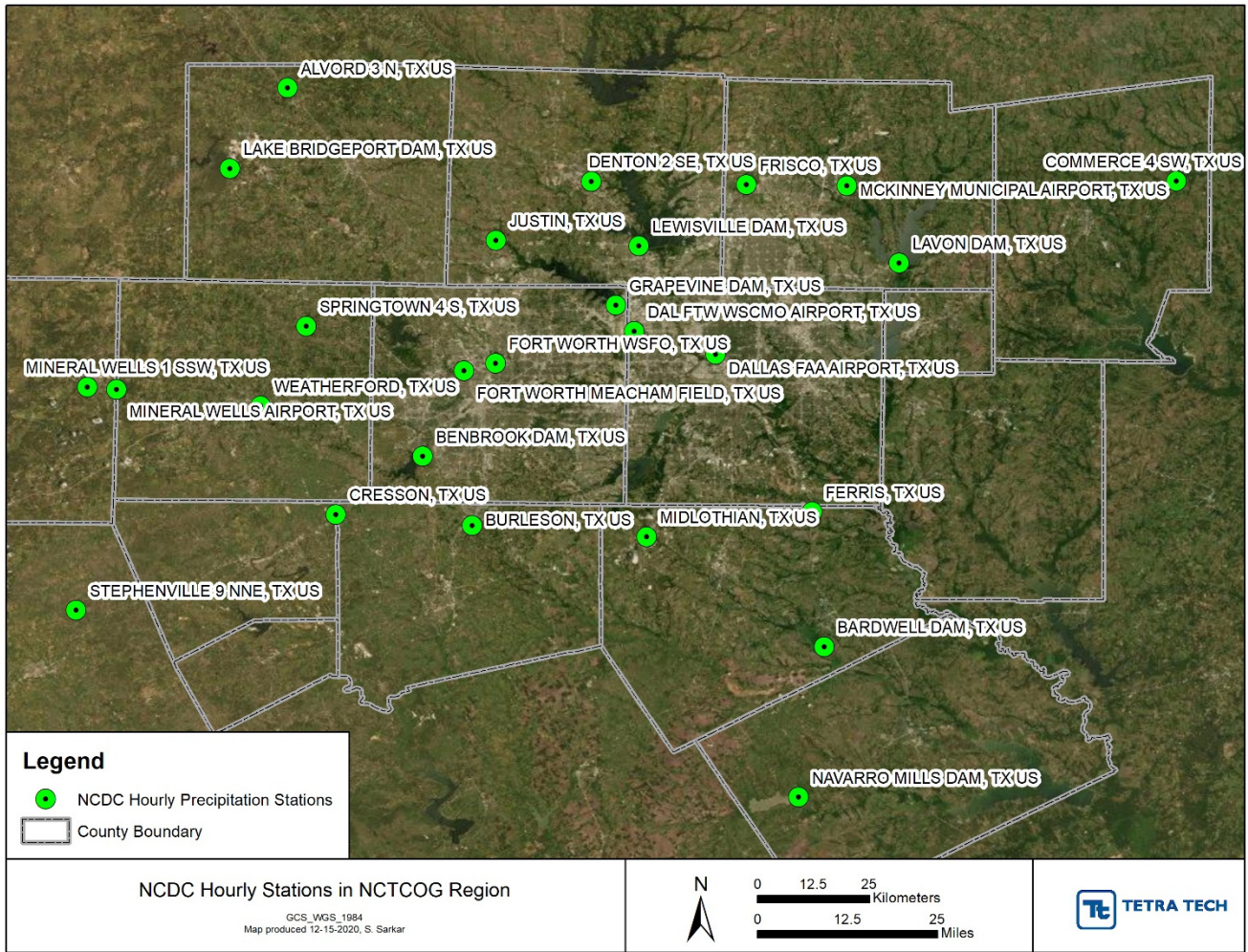

Figure 2. NCD Hourly Stations with 30-yearsof Rainfall Data.

The results of the analysis using WQ-COSM for the Fort Worth Meacham Field (COOP:413284) to determine optimal WQCV basin size are shown in Figure 3. The results of the analysis suggest that the optimal WQCV basin size is 0.95-inches (based on runoff volume capture) and 0.88-inches (based on storm events capture). Reducing the WQCV basin emptying time to 24-hours from 40-hours results in slightly lower WQCV basin sizes - 0.88-inches based on runoff volume and 0.80-inches based on storm events captured. Increasing the dry period separation for new storm to 12-hours from 6-hours results in higher WQCV basin sizes - 0.98-inches based on runoff volume and 0.89-inches based on storm events captured.

In contrast, the water quality protection volume ( $Q_{wv}$ ) using the current iSWM Technical Manual methodology is calculated as 1.43-inches, assuming 100% imperviousness and 85<sup>th</sup>-percentile storm depth of 1.5-inches. The 85<sup>th</sup>-percentile 24-hour rainfall depth for the Fort Worth Meacham Field based on the NCD continuous data from 1940 to 2013 is 1.2-inches. The  $Q_{wv}$  using 1.2-inches as the 85<sup>th</sup>-percentile rainfall depth is calculated as 1.14-inches. The results of the WQCV analysis for all stations shown in Figure 2 are summarized in Appendix A. The re-calculated 85<sup>th</sup>-percentile storm depths using continuous rainfall data for the same locations are summarized in Appendix B.

WQCV Table -- 100% Imperviousness									
Optimized Values:									
WQCV Based on Runoff Volume Captured					WQCV Based on Storm Events Captured				
Percent of Volume Captured (%)	WQCV (in)	Volume Captured (in)	Number of Storms Captured	Percent of Storms Captured (%)	Percent of Storms Captured (%)	WQCV (in)	Number of Storms Captured	Volume Captured (%)	Percent of Volume Captured (%)
84.9%	0.9525	1441.85	2,934	87.31%	85.6%	0.8763	2,878	1400.38	82.41%
Incremental WQCV Values:									
WQCV Based on Runoff Volume Captured					WQCV Based on Storm Events Captured				
Percent of Volume Captured (%)	WQCV (in)	Volume Captured (in)	Number of Storms Captured	Percent of Storms Captured (%)	Percent of Storms Captured (%)	WQCV (in)	Number of Storms Captured	Volume Captured (%)	Percent of Volume Captured (%)
0.0%	0.0000	0.00	0	0.00%	0.0%	0.0000	0	0.00	0.00%
10.0%	0.0525	169.93	42	1.25%	10.0%	0.1020	336	317.95	18.71%
20.0%	0.1099	339.85	420	12.51%	20.0%	0.1335	672	405.34	23.85%
30.0%	0.1750	509.78	1,004	29.89%	30.0%	0.1756	1,008	511.18	30.08%
40.0%	0.2520	679.70	1,432	42.61%	40.0%	0.2341	1,344	644.61	37.93%
50.0%	0.3449	849.63	1,832	54.51%	50.0%	0.3027	1,680	779.15	45.85%
60.0%	0.4586	1019.56	2,181	64.92%	60.0%	0.4008	2,016	937.57	55.18%
70.0%	0.6045	1189.48	2,494	74.23%	70.0%	0.5321	2,352	1110.69	65.36%
72.5%	0.6491	1231.96	2,567	76.39%	72.5%	0.5748	2,436	1157.21	68.10%
75.0%	0.6960	1274.44	2,643	78.65%	75.0%	0.6196	2,520	1204.36	70.88%
77.5%	0.7492	1316.93	2,734	81.37%	77.5%	0.6725	2,604	1253.88	73.79%
80.0%	0.8100	1359.41	2,813	83.73%	80.0%	0.7224	2,688	1295.51	76.24%
82.5%	0.8789	1401.89	2,880	85.70%	82.5%	0.7754	2,772	1336.10	78.63%
85.0%	0.9574	1444.37	2,937	87.40%	85.0%	0.8494	2,856	1384.87	81.50%
87.5%	1.0469	1486.85	3,000	89.28%	87.5%	0.9622	2,940	1446.81	85.14%
90.0%	1.1536	1529.33	3,063	91.15%	90.0%	1.0845	3,024	1502.78	88.44%
92.5%	1.2856	1571.81	3,131	93.19%	92.5%	1.2406	3,108	1558.39	91.71%
95.0%	1.4654	1614.30	3,201	95.28%	95.0%	1.4396	3,192	1609.26	94.70%
97.5%	1.7687	1656.78	3,279	97.59%	97.5%	1.7525	3,276	1655.22	97.41%
100.0%	3.5050	1699.26	3,360	100.00%	100.0%	3.5050	3,360	1699.26	100.00%

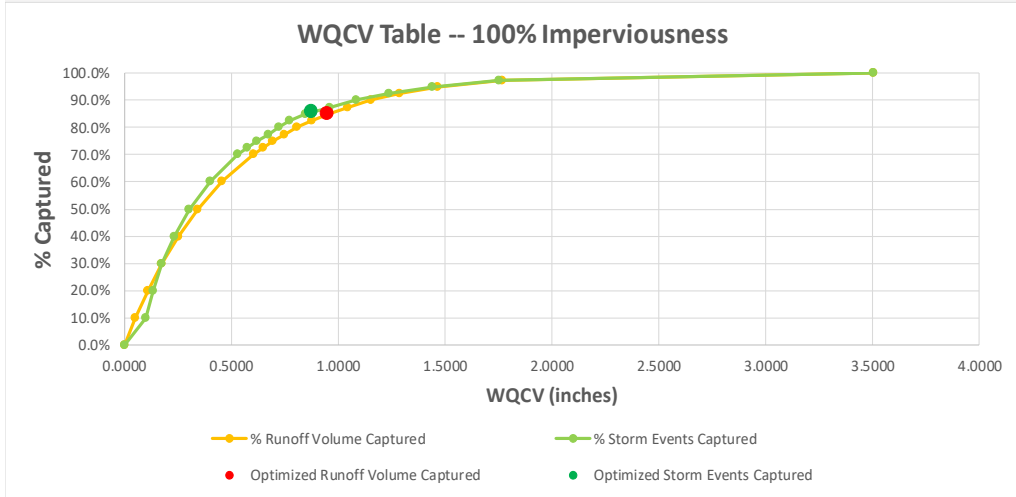

Figure 3. Optimal WQCV Basin Size using WQ-COSM for the Fort Worth Meacham Field.

A scatter plot of the water quality capture volume (WQCV) using WQ-COSM against the water quality protection volume calculated using the NCTCOG method is shown in Figure 4. The plot suggests that WQCV is generally lower than QWV for the NCDC stations shown in Figure 2.

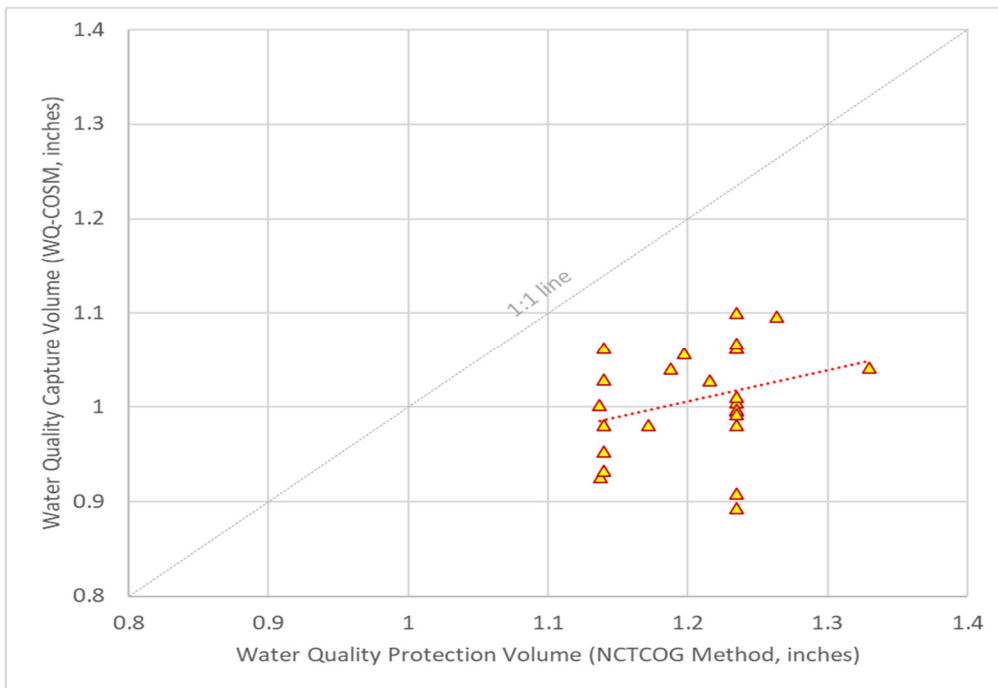

Figure 4. Scatter Plot of WQCV and QWV.

## CONCLUSIONS

The water quality capture volume was calculated using the empirical approach recommended in the iSWM Technical Manual and the Water Quality Capture Optimization Statistical Model (WQ-COSM). The results based on the iSWM method results in a higher volume capture requirement. The optimal capture volume calculated using WQ-COSM are slightly lower than those calculated using the iSWM equations. Note however that the WQ-COSM outcomes are sensitive to the input parameters and should be carefully reviewed while calculating optimal water quality capture volumes.

The WQ-COSM methodology is based on analyzing long-term continuous rainfall-runoff data to determine the capacity of a detention basin for optimal runoff capture. Basins sized using the WQ-COSM methodology may or may not completely capture the runoff associated with the 85<sup>th</sup>-percentile storm. The 85<sup>th</sup>-percentile storm event is often regarded as a reasonable target event to address the vast majority of smaller, pollutant-loaded storms. The analysis presented herein using WQ-COSM generally shows a smaller capture volume than the 85<sup>th</sup>-percentile storm event. However, neither WQ-COSM nor the 85<sup>th</sup>-percentile analysis determine the actual amount of pollutants removed. Depending on site-specific water quality compliance targets, pollutant capture should be evaluated through monitoring or water quality modeling. The initial estimated basin sizes determined using the required methodology should be revised accordingly based on pollutant capture. The methods discussed herein also do not evaluate the cost of pollutant removal based on basin capacity. Supplementary analyses that determine the optimal basin size based on the cost of pollutant removal (such as the USEPA’s SUSTAIN model<sup>2</sup>) may also be considered.

---

<sup>2</sup> <https://www.epa.gov/water-research/system-urban-stormwater-treatment-and-analysis-integration-sustain>

Our recommendation to the iSWM Technical committee based on the water quality capture volume following the WQ-COSM methodology and comparison water quality protection volume based on the 85<sup>th</sup>-percentile storm runoff are as follows -

- 1) The WQ-COSM methodology optimizes WQCV based on a long-term analysis of rainfall data and therefore provides a sound basis for BMP sizing. The WQCV determined using WQ-COSM is consistently smaller than the volume determined for complete capture of the 85<sup>th</sup>-percentile storm. A smaller WQCV also implies lower capital costs. The WQCV based on the WQ-COSM methodology is therefore recommended as an alternate option to the iSWM's 85<sup>th</sup>-percentile storm capture method.
- 2) Instances where a BMP is being designed to address specific water quality targets, it is recommended that the capture volume be calculated using both methods to evaluate if the level of treatment required to meet water quality criteria by one or the other or both methods. The low-cost option capable of achieving water quality goals should be selected.



# Appendix A

## WQ-COSM Results for Selected NCDC Stations

WQCV Table -- 100% Imperviousness									
Optimized Values:									
WQCV Based on Runoff Volume Captured					WQCV Based on Storm Events Captured				
Percent of Volume Captured (%)	WQCV (in)	Volume Captured (in)	Number of Storms Captured	Percent of Storms Captured (%)	Percent of Storms Captured (%)	WQCV (in)	Number of Storms Captured	Volume Captured (%)	Percent of Volume Captured (%)
86.2%	0.9808	1279.59	2,837	89.68%	88.0%	0.9082	2,783	1249.14	84.10%
Incremental WQCV Values:									
WQCV Based on Runoff Volume Captured					WQCV Based on Storm Events Captured				
Percent of Volume Captured (%)	WQCV (in)	Volume Captured (in)	Number of Storms Captured	Percent of Storms Captured (%)	Percent of Storms Captured (%)	WQCV (in)	Number of Storms Captured	Volume Captured (%)	Percent of Volume Captured (%)
0.0%	0.0000	0.00	0	0.00%	0.0%	0.0000	0	0.00	0.00%
10.0%	0.0500	148.53	30	0.96%	10.0%	0.0972	316	277.53	18.68%
20.0%	0.1049	297.06	402	12.72%	20.0%	0.1256	633	349.42	23.52%
30.0%	0.1677	445.59	988	31.23%	30.0%	0.1613	949	432.34	29.11%
40.0%	0.2430	594.12	1,401	44.28%	40.0%	0.2131	1,265	539.90	36.35%
50.0%	0.3329	742.65	1,756	55.52%	50.0%	0.2860	1,582	669.67	45.09%
60.0%	0.4411	891.18	2,070	65.43%	60.0%	0.3750	1,898	804.66	54.18%
70.0%	0.5818	1039.71	2,384	75.37%	70.0%	0.5004	2,214	959.11	64.57%
72.5%	0.6265	1076.84	2,449	77.43%	72.5%	0.5374	2,293	996.56	67.10%
75.0%	0.6742	1113.97	2,517	79.57%	75.0%	0.5760	2,372	1034.12	69.62%
77.5%	0.7265	1151.11	2,588	81.82%	77.5%	0.6280	2,451	1078.11	72.59%
80.0%	0.7878	1188.24	2,662	84.17%	80.0%	0.6842	2,530	1121.11	75.48%
82.5%	0.8573	1225.37	2,740	86.63%	82.5%	0.7442	2,609	1161.85	78.22%
85.0%	0.9381	1262.50	2,805	88.69%	85.0%	0.8106	2,689	1201.06	80.86%
87.5%	1.0342	1299.64	2,870	90.75%	87.5%	0.8875	2,768	1239.91	83.48%
90.0%	1.1491	1336.77	2,918	92.24%	90.0%	0.9948	2,847	1285.07	86.52%
92.5%	1.2878	1373.90	2,964	93.71%	92.5%	1.1696	2,926	1342.86	90.41%
95.0%	1.4720	1411.03	3,031	95.83%	95.0%	1.3951	3,005	1397.36	94.08%
97.5%	1.8122	1448.17	3,098	97.94%	97.5%	1.6766	3,084	1436.47	96.71%
100.0%	3.9232	1485.30	3,163	100.00%	100.0%	3.9232	3,163	1485.30	100.00%

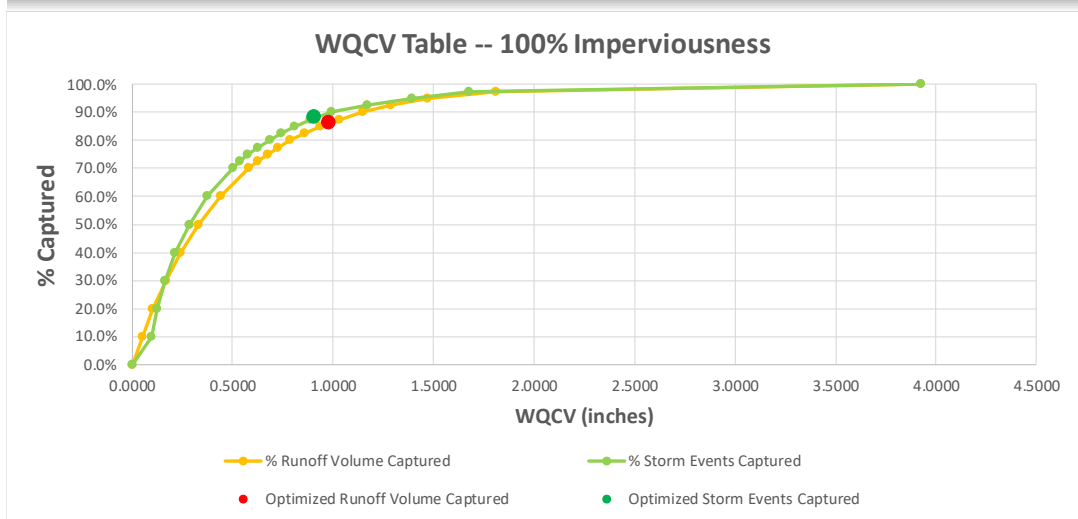

Figure 5. Optimal WQCV Basin Size using WQ-COSM for the LAKE BRIDGEPORT DAM TX US (COOP:414972).

WQCV Table -- 100% Imperviousness									
Optimized Values:									
WQCV Based on Runoff Volume Captured					WQCV Based on Storm Events Captured				
Percent of Volume Captured (%)	WQCV (in)	Volume Captured (in)	Number of Storms Captured	Percent of Storms Captured (%)	Percent of Storms Captured (%)	WQCV (in)	Number of Storms Captured	Volume Captured (%)	Percent of Volume Captured (%)
83.5%	0.9808	1387.72	2,871	87.22%	83.5%	0.8355	2,748	1305.92	78.60%
Incremental WQCV Values:									
WQCV Based on Runoff Volume Captured					WQCV Based on Storm Events Captured				
Percent of Volume Captured (%)	WQCV (in)	Volume Captured (in)	Number of Storms Captured	Percent of Storms Captured (%)	Percent of Storms Captured (%)	WQCV (in)	Number of Storms Captured	Volume Captured (%)	Percent of Volume Captured (%)
0.0%	0.0000	0.00	0	0.00%	0.0%	0.0000	0	0.00	0.00%
10.0%	0.0552	166.15	17	0.53%	10.0%	0.1003	329	291.07	17.52%
20.0%	0.1161	332.31	504	15.31%	20.0%	0.1301	658	368.78	22.20%
30.0%	0.1863	498.46	1,082	32.88%	30.0%	0.1711	987	465.06	27.99%
40.0%	0.2696	664.61	1,505	45.73%	40.0%	0.2265	1,316	583.75	35.13%
50.0%	0.3690	830.77	1,883	57.21%	50.0%	0.3037	1,646	725.36	43.66%
60.0%	0.4914	996.92	2,197	66.75%	60.0%	0.4008	1,975	876.20	52.73%
70.0%	0.6479	1163.07	2,506	76.14%	70.0%	0.5428	2,304	1056.62	63.59%
72.5%	0.6968	1204.61	2,580	78.40%	72.5%	0.5834	2,386	1101.26	66.28%
75.0%	0.7494	1246.15	2,650	80.53%	75.0%	0.6276	2,468	1143.68	68.83%
77.5%	0.8071	1287.69	2,716	82.52%	77.5%	0.6766	2,551	1187.78	71.49%
80.0%	0.8719	1329.23	2,789	84.75%	80.0%	0.7342	2,633	1234.99	74.33%
82.5%	0.9466	1370.77	2,841	86.32%	82.5%	0.8063	2,715	1287.22	77.47%
85.0%	1.0322	1412.30	2,909	88.40%	85.0%	0.8840	2,797	1335.96	80.41%
87.5%	1.1313	1453.84	2,960	89.94%	87.5%	0.9913	2,880	1392.94	83.83%
90.0%	1.2459	1495.38	3,017	91.66%	90.0%	1.1350	2,962	1455.31	87.59%
92.5%	1.3865	1536.92	3,073	93.39%	92.5%	1.3108	3,044	1515.80	91.23%
95.0%	1.5718	1578.46	3,144	95.52%	95.0%	1.5314	3,126	1570.87	94.54%
97.5%	1.8729	1620.00	3,205	97.38%	97.5%	1.9042	3,209	1623.22	97.69%
100.0%	3.3420	1661.53	3,291	100.00%	100.0%	3.3420	3,291	1661.53	100.00%

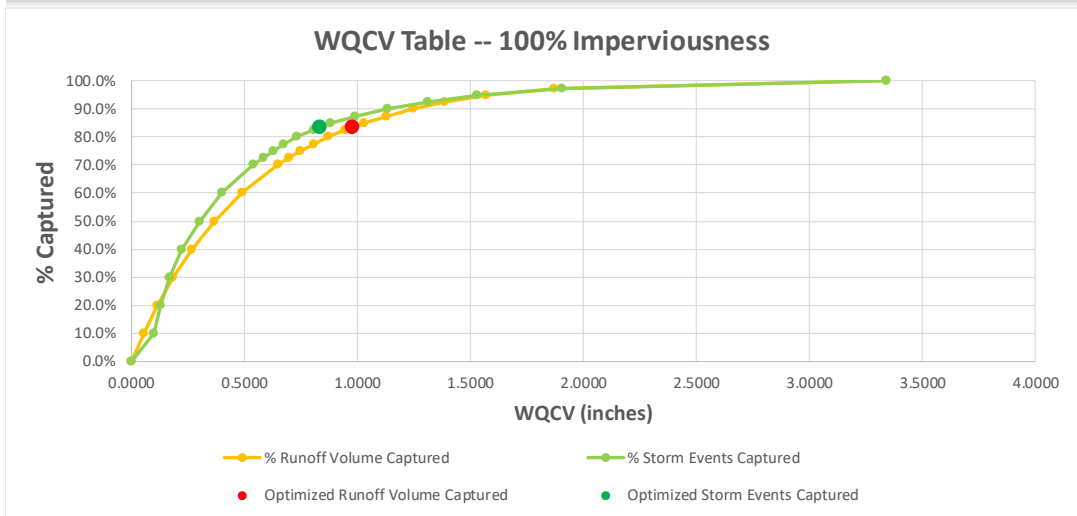

Figure 6. Optimal WQCV Basin Size using WQ-COSM for the LAVON DAM TX US (COOP:415094).

WQCV Table -- 100% Imperviousness									
Optimized Values:									
WQCV Based on Runoff Volume Captured					WQCV Based on Storm Events Captured				
Percent of Volume Captured (%)	WQCV (in)	Volume Captured (in)	Number of Storms Captured	Percent of Storms Captured (%)	Percent of Storms Captured (%)	WQCV (in)	Number of Storms Captured	Volume Captured (%)	Percent of Volume Captured (%)
84.2%	1.0278	1280.64	2,381	86.60%	82.4%	0.8633	2,266	1200.03	78.94%
Incremental WQCV Values:									
WQCV Based on Runoff Volume Captured					WQCV Based on Storm Events Captured				
Percent of Volume Captured (%)	WQCV (in)	Volume Captured (in)	Number of Storms Captured	Percent of Storms Captured (%)	Percent of Storms Captured (%)	WQCV (in)	Number of Storms Captured	Volume Captured (%)	Percent of Volume Captured (%)
0.0%	0.0000	0.00	0	0.00%	0.0%	0.0000	0	0.00	0.00%
10.0%	0.0567	152.03	54	1.98%	10.0%	0.1065	275	275.98	18.15%
20.0%	0.1188	304.05	374	13.61%	20.0%	0.1405	550	353.71	23.27%
30.0%	0.1897	456.08	854	31.06%	30.0%	0.1831	825	443.55	29.18%
40.0%	0.2744	608.10	1,193	43.38%	40.0%	0.2459	1,100	562.02	36.97%
50.0%	0.3759	760.13	1,507	54.81%	50.0%	0.3308	1,375	698.48	45.94%
60.0%	0.5001	912.16	1,803	65.60%	60.0%	0.4289	1,649	829.22	54.54%
70.0%	0.6624	1064.18	2,057	74.84%	70.0%	0.5721	1,924	985.24	64.81%
72.5%	0.7128	1102.19	2,114	76.89%	72.5%	0.6180	1,993	1025.87	67.48%
75.0%	0.7665	1140.20	2,169	78.91%	75.0%	0.6665	2,062	1067.23	70.20%
77.5%	0.8243	1178.20	2,224	80.91%	77.5%	0.7279	2,130	1113.58	73.25%
80.0%	0.8923	1216.21	2,296	83.53%	80.0%	0.7982	2,199	1161.17	76.38%
82.5%	0.9689	1254.22	2,348	85.42%	82.5%	0.8656	2,268	1201.31	79.02%
85.0%	1.0544	1292.22	2,394	87.10%	85.0%	0.9499	2,337	1245.00	81.89%
87.5%	1.1527	1330.23	2,455	89.29%	87.5%	1.0742	2,405	1300.52	85.55%
90.0%	1.2734	1368.23	2,502	91.00%	90.0%	1.2012	2,474	1346.07	88.54%
92.5%	1.4190	1406.24	2,562	93.19%	92.5%	1.3714	2,543	1394.77	91.75%
95.0%	1.6121	1444.25	2,618	95.23%	95.0%	1.5830	2,612	1439.45	94.68%
97.5%	1.9161	1482.25	2,674	97.28%	97.5%	1.9828	2,680	1488.02	97.88%
100.0%	3.5355	1520.26	2,749	100.00%	100.0%	3.5355	2,749	1520.26	100.00%

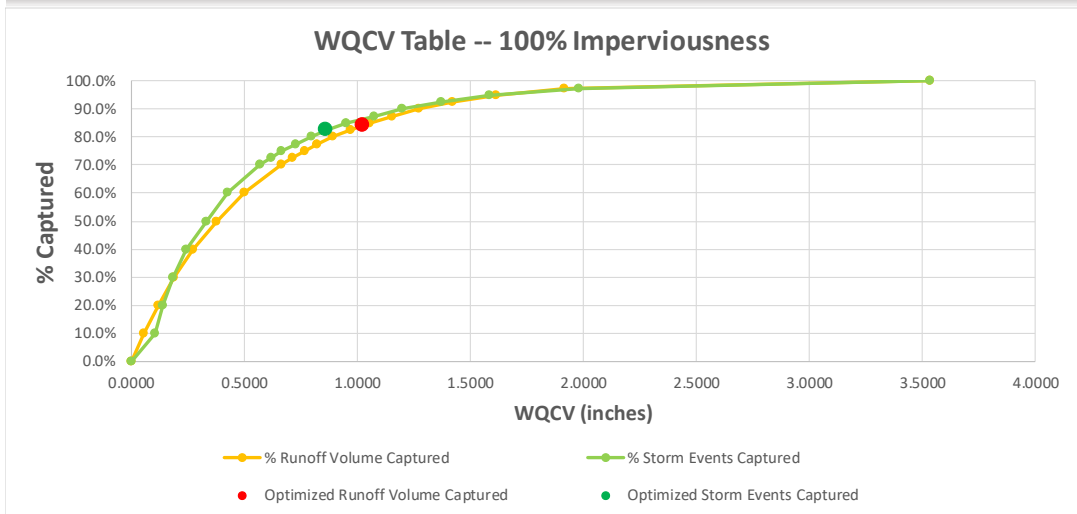

Figure 7. Optimal WQCV Basin Size using WQ-COSM for the LEWISVILLE DAM TX US (COOP:415192).

WQCV Table -- 100% Imperviousness									
Optimized Values:									
WQCV Based on Runoff Volume Captured					WQCV Based on Storm Events Captured				
Percent of Volume Captured (%)	WQCV (in)	Volume Captured (in)	Number of Storms Captured	Percent of Storms Captured (%)	Percent of Storms Captured (%)	WQCV (in)	Number of Storms Captured	Volume Captured (%)	Percent of Volume Captured (%)
57.9%	0.7143	12.39	22	70.97%	66.1%	0.5665	21	10.81	50.55%
Incremental WQCV Values:									
WQCV Based on Runoff Volume Captured					WQCV Based on Storm Events Captured				
Percent of Volume Captured (%)	WQCV (in)	Volume Captured (in)	Number of Storms Captured	Percent of Storms Captured (%)	Percent of Storms Captured (%)	WQCV (in)	Number of Storms Captured	Volume Captured (%)	Percent of Volume Captured (%)
0.0%	0.0000	0.00	0	0.00%	0.0%	0.0000	0	0.00	0.00%
10.0%	0.0793	2.14	1	1.97%	10.0%	0.1115	3	3.00	14.02%
20.0%	0.1617	4.28	10	30.86%	20.0%	0.1305	6	3.50	16.38%
30.0%	0.2636	6.42	12	39.84%	30.0%	0.1552	9	4.13	19.30%
40.0%	0.3880	8.56	17	54.04%	40.0%	0.2660	12	6.46	30.22%
50.0%	0.5559	10.69	20	65.43%	50.0%	0.3571	16	8.09	37.81%
60.0%	0.7654	12.83	23	74.19%	60.0%	0.4335	19	9.21	43.07%
70.0%	1.0443	14.97	24	77.42%	70.0%	0.7069	22	12.32	57.62%
72.5%	1.1193	15.51	24	77.42%	72.5%	0.7260	22	12.50	58.43%
75.0%	1.1944	16.04	24	77.42%	75.0%	0.8990	23	13.92	65.09%
77.5%	1.2694	16.58	24	77.42%	77.5%	1.2820	24	16.67	77.92%
80.0%	1.3498	17.11	25	80.65%	80.0%	1.3202	25	16.93	79.15%
82.5%	1.4433	17.65	27	87.10%	82.5%	1.3935	26	17.36	81.17%
85.0%	1.5371	18.18	27	87.10%	85.0%	1.4126	26	17.47	81.68%
87.5%	1.6341	18.71	27	87.10%	87.5%	1.7303	27	19.16	89.60%
90.0%	1.7485	19.25	27	88.69%	90.0%	1.7685	28	19.34	90.44%
92.5%	1.8634	19.78	28	90.32%	92.5%	2.2008	29	21.16	98.93%
95.0%	1.9792	20.32	28	90.32%	95.0%	2.2771	29	21.35	99.84%
97.5%	2.1162	20.85	28	90.32%	97.5%	2.2962	30	21.37	99.92%
100.0%	2.3153	21.39	31	100.00%	100.0%	2.3153	31	21.39	100.00%

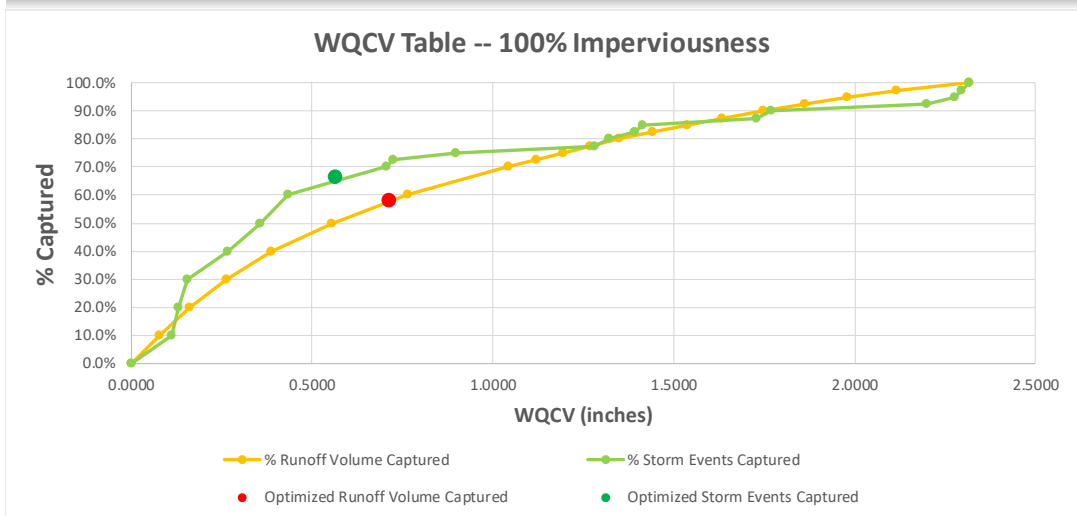

Figure 8. Optimal WQCV Basin Size using WQ-COSM for the MCKINNEY MUNICIPAL AIRPORT TX US (COOP:415766).

WQCV Table -- 100% Imperviousness									
Optimized Values:									
WQCV Based on Runoff Volume Captured					WQCV Based on Storm Events Captured				
Percent of Volume Captured (%)	WQCV (in)	Volume Captured (in)	Number of Storms Captured	Percent of Storms Captured (%)	Percent of Storms Captured (%)	WQCV (in)	Number of Storms Captured	Volume Captured (%)	Percent of Volume Captured (%)
84.9%	1.0411	894.62	1,980	88.79%	84.9%	0.8745	1,894	838.18	79.53%
Incremental WQCV Values:									
WQCV Based on Runoff Volume Captured					WQCV Based on Storm Events Captured				
Percent of Volume Captured (%)	WQCV (in)	Volume Captured (in)	Number of Storms Captured	Percent of Storms Captured (%)	Percent of Storms Captured (%)	WQCV (in)	Number of Storms Captured	Volume Captured (%)	Percent of Volume Captured (%)
0.0%	0.0000	0.00	0	0.00%	0.0%	0.0000	0	0.00	0.00%
10.0%	0.0540	105.40	1	0.03%	10.0%	0.1078	223	200.40	19.01%
20.0%	0.1145	210.79	284	12.73%	20.0%	0.1324	446	238.52	22.63%
30.0%	0.1861	316.19	820	36.79%	30.0%	0.1571	669	276.65	26.25%
40.0%	0.2721	421.59	1,088	48.80%	40.0%	0.2075	892	343.42	32.58%
50.0%	0.3745	526.98	1,315	58.99%	50.0%	0.2831	1,115	433.57	41.14%
60.0%	0.4980	632.38	1,552	69.58%	60.0%	0.3864	1,338	538.20	51.06%
70.0%	0.6592	737.78	1,745	78.23%	70.0%	0.5048	1,561	637.28	60.47%
72.5%	0.7096	764.13	1,787	80.15%	72.5%	0.5517	1,617	670.03	63.57%
75.0%	0.7630	790.48	1,827	81.91%	75.0%	0.5986	1,673	701.28	66.54%
77.5%	0.8215	816.83	1,860	83.39%	77.5%	0.6455	1,728	729.52	69.22%
80.0%	0.8873	843.17	1,902	85.29%	80.0%	0.7054	1,784	761.97	72.29%
82.5%	0.9608	869.52	1,942	87.10%	82.5%	0.7863	1,840	800.99	76.00%
85.0%	1.0454	895.87	1,982	88.88%	85.0%	0.8775	1,896	839.36	79.64%
87.5%	1.1440	922.22	2,021	90.63%	87.5%	0.9791	1,951	875.72	83.09%
90.0%	1.2619	948.57	2,065	92.60%	90.0%	1.1049	2,007	912.30	86.56%
92.5%	1.4164	974.92	2,110	94.62%	92.5%	1.2549	2,063	947.27	89.88%
95.0%	1.6468	1001.27	2,156	96.66%	95.0%	1.4552	2,119	980.01	92.98%
97.5%	2.0426	1027.62	2,190	98.21%	97.5%	1.8453	2,174	1016.49	96.44%
100.0%	3.6645	1053.97	2,230	100.00%	100.0%	3.6645	2,230	1053.97	100.00%

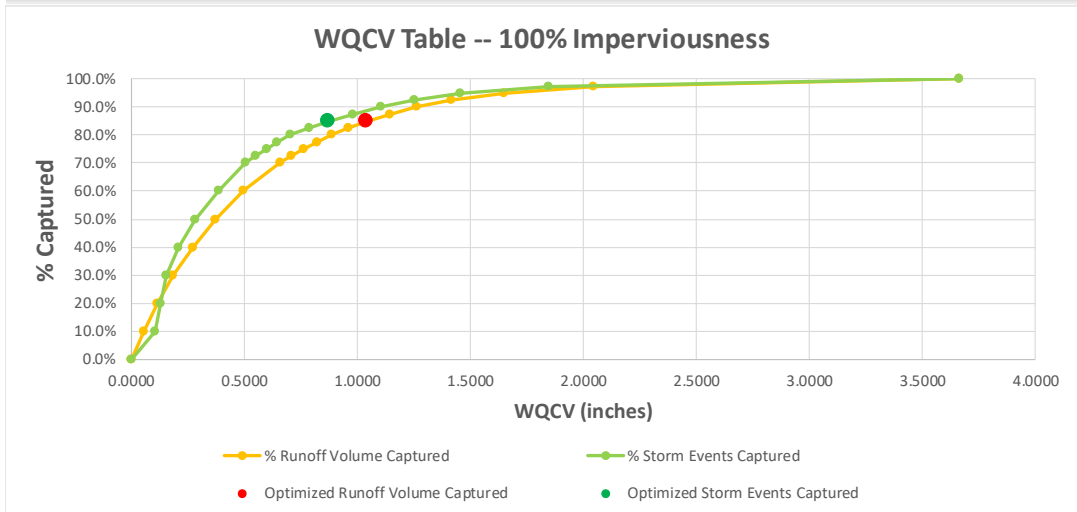

Figure 9. Optimal WQCV Basin Size using WQ-COSM for the MIDLOTHIAN TX US (COOP:415897).

WQCV Table -- 100% Imperviousness									
Optimized Values:									
WQCV Based on Runoff Volume Captured					WQCV Based on Storm Events Captured				
Percent of Volume Captured (%)	WQCV (in)	Volume Captured (in)	Number of Storms Captured	Percent of Storms Captured (%)	Percent of Storms Captured (%)	WQCV (in)	Number of Storms Captured	Volume Captured (%)	Percent of Volume Captured (%)
84.0%	0.9090	1133.22	2,506	86.92%	84.7%	0.8417	2,443	1101.42	81.68%
Incremental WQCV Values:									
WQCV Based on Runoff Volume Captured					WQCV Based on Storm Events Captured				
Percent of Volume Captured (%)	WQCV (in)	Volume Captured (in)	Number of Storms Captured	Percent of Storms Captured (%)	Percent of Storms Captured (%)	WQCV (in)	Number of Storms Captured	Volume Captured (%)	Percent of Volume Captured (%)
0.0%	0.0000	0.00	0	0.00%	0.0%	0.0000	0	0.00	0.00%
10.0%	0.0512	134.85	8	0.26%	10.0%	0.0929	288	235.90	17.49%
20.0%	0.1076	269.69	449	15.58%	20.0%	0.1193	577	296.42	21.98%
30.0%	0.1731	404.54	968	33.57%	30.0%	0.1554	865	370.97	27.51%
40.0%	0.2510	539.39	1,330	46.14%	40.0%	0.2063	1,153	466.41	34.59%
50.0%	0.3430	674.24	1,596	55.37%	50.0%	0.2841	1,442	590.62	43.80%
60.0%	0.4559	809.08	1,889	65.52%	60.0%	0.3916	1,730	735.70	54.56%
70.0%	0.5996	943.93	2,177	75.50%	70.0%	0.5141	2,018	867.82	64.36%
72.5%	0.6432	977.64	2,224	77.16%	72.5%	0.5497	2,090	901.19	66.83%
75.0%	0.6897	1011.36	2,275	78.91%	75.0%	0.5912	2,162	936.75	69.47%
77.5%	0.7402	1045.07	2,340	81.18%	77.5%	0.6533	2,234	985.25	73.06%
80.0%	0.7984	1078.78	2,395	83.07%	80.0%	0.7139	2,306	1027.53	76.20%
82.5%	0.8635	1112.49	2,468	85.62%	82.5%	0.7808	2,378	1068.56	79.24%
85.0%	0.9387	1146.20	2,527	87.66%	85.0%	0.8482	2,451	1104.72	81.92%
87.5%	1.0276	1179.91	2,577	89.37%	87.5%	0.9324	2,523	1143.42	84.79%
90.0%	1.1328	1213.63	2,635	91.41%	90.0%	1.0555	2,595	1189.42	88.20%
92.5%	1.2639	1247.34	2,688	93.24%	92.5%	1.2007	2,667	1232.09	91.37%
95.0%	1.4402	1281.05	2,750	95.40%	95.0%	1.4135	2,739	1277.00	94.70%
97.5%	1.7489	1314.76	2,818	97.73%	97.5%	1.7110	2,811	1311.56	97.26%
100.0%	3.1648	1348.47	2,883	100.00%	100.0%	3.1648	2,883	1348.47	100.00%

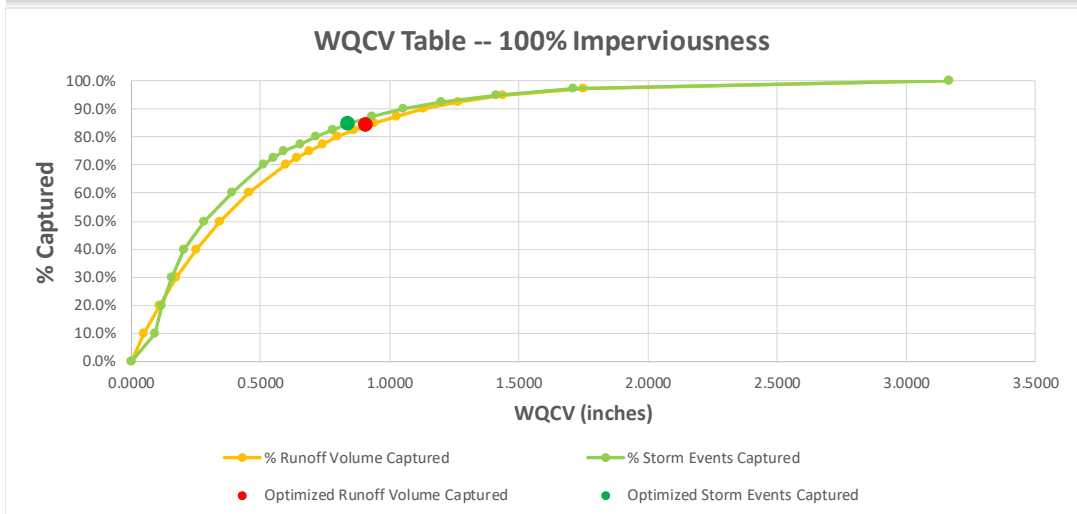

Figure 10. Optimal WQCV Basin Size using WQ-COSM for the MINERAL WELLS 1 SSW TX US (COOP:415957).

WQCV Table -- 100% Imperviousness									
Optimized Values:									
WQCV Based on Runoff Volume Captured					WQCV Based on Storm Events Captured				
Percent of Volume Captured (%)	WQCV (in)	Volume Captured (in)	Number of Storms Captured	Percent of Storms Captured (%)	Percent of Storms Captured (%)	WQCV (in)	Number of Storms Captured	Volume Captured (%)	Percent of Volume Captured (%)
84.4%	0.9258	233.54	383	84.36%	84.4%	0.9258	383	233.54	84.44%
Incremental WQCV Values:									
WQCV Based on Runoff Volume Captured					WQCV Based on Storm Events Captured				
Percent of Volume Captured (%)	WQCV (in)	Volume Captured (in)	Number of Storms Captured	Percent of Storms Captured (%)	Percent of Storms Captured (%)	WQCV (in)	Number of Storms Captured	Volume Captured (%)	Percent of Volume Captured (%)
0.0%	0.0000	0.00	0	0.00%	0.0%	0.0000	0	0.00	0.00%
10.0%	0.0559	27.66	8	1.80%	10.0%	0.1014	45	48.60	17.57%
20.0%	0.1164	55.32	62	13.57%	20.0%	0.1469	91	68.37	24.72%
30.0%	0.1846	82.97	117	25.82%	30.0%	0.2124	136	93.46	33.79%
40.0%	0.2621	110.63	167	36.87%	40.0%	0.2853	182	118.21	42.74%
50.0%	0.3524	138.29	221	48.59%	50.0%	0.3657	227	141.80	51.27%
60.0%	0.4645	165.95	270	59.44%	60.0%	0.4709	272	167.41	60.53%
70.0%	0.6073	193.61	314	69.13%	70.0%	0.6244	318	196.49	71.04%
72.5%	0.6503	200.52	324	71.41%	72.5%	0.6702	329	203.63	73.62%
75.0%	0.6958	207.44	335	73.80%	75.0%	0.7225	341	211.12	76.33%
77.5%	0.7459	214.35	345	76.05%	77.5%	0.7702	352	217.37	78.59%
80.0%	0.8034	221.27	362	79.74%	80.0%	0.8072	363	221.71	80.16%
82.5%	0.8686	228.18	374	82.38%	82.5%	0.8728	375	228.60	82.65%
85.0%	0.9432	235.10	386	85.03%	85.0%	0.9424	386	235.02	84.97%
87.5%	1.0297	242.01	393	86.60%	87.5%	1.0529	397	243.62	88.08%
90.0%	1.1360	248.92	407	89.58%	90.0%	1.1795	409	251.39	90.89%
92.5%	1.2634	255.84	412	90.81%	92.5%	1.3710	420	260.91	94.33%
95.0%	1.4194	262.75	423	93.28%	95.0%	1.4941	431	265.16	95.87%
97.5%	1.7319	269.67	442	97.25%	97.5%	1.7710	443	270.23	97.70%
100.0%	3.2231	276.58	454	100.00%	100.0%	3.2231	454	276.58	100.00%

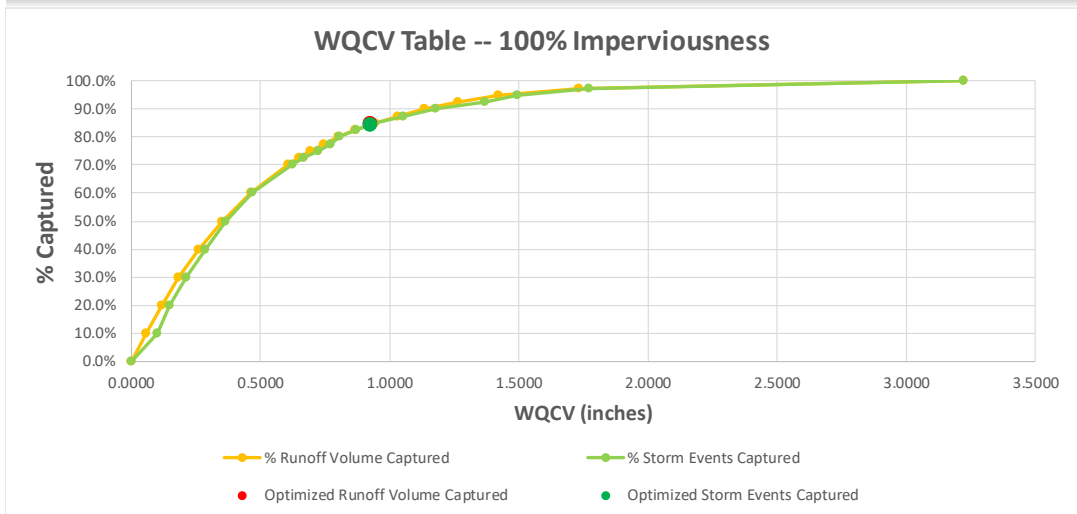

Figure 11. Optimal WQCV Basin Size using WQ-COSM for the MINERAL WELLS AIRPORT TX US (COOP:415958).

WQCV Table -- 100% Imperviousness									
Optimized Values:									
WQCV Based on Runoff Volume Captured					WQCV Based on Storm Events Captured				
Percent of Volume Captured (%)	WQCV (in)	Volume Captured (in)	Number of Storms Captured	Percent of Storms Captured (%)	Percent of Storms Captured (%)	WQCV (in)	Number of Storms Captured	Volume Captured (%)	Percent of Volume Captured (%)
85.0%	1.0632	1248.64	2,534	88.74%	84.3%	0.8931	2,407	1172.27	79.80%
Incremental WQCV Values:									
WQCV Based on Runoff Volume Captured					WQCV Based on Storm Events Captured				
Percent of Volume Captured (%)	WQCV (in)	Volume Captured (in)	Number of Storms Captured	Percent of Storms Captured (%)	Percent of Storms Captured (%)	WQCV (in)	Number of Storms Captured	Volume Captured (%)	Percent of Volume Captured (%)
0.0%	0.0000	0.00	0	0.00%	0.0%	0.0000	0	0.00	0.00%
10.0%	0.0560	146.90	23	0.81%	10.0%	0.1089	286	273.90	18.65%
20.0%	0.1182	293.79	383	13.42%	20.0%	0.1361	571	331.99	22.60%
30.0%	0.1905	440.69	1,014	35.51%	30.0%	0.1633	857	390.08	26.56%
40.0%	0.2767	587.58	1,348	47.21%	40.0%	0.2210	1,142	494.65	33.67%
50.0%	0.3798	734.48	1,638	57.36%	50.0%	0.3043	1,428	629.21	42.83%
60.0%	0.5041	881.37	1,935	67.78%	60.0%	0.4078	1,713	770.74	52.47%
70.0%	0.6684	1028.27	2,187	76.60%	70.0%	0.5392	1,999	915.63	62.33%
72.5%	0.7186	1064.99	2,241	78.48%	72.5%	0.5808	2,070	954.93	65.01%
75.0%	0.7715	1101.71	2,293	80.33%	75.0%	0.6322	2,141	998.73	67.99%
77.5%	0.8318	1138.44	2,348	82.24%	77.5%	0.6910	2,213	1045.49	71.17%
80.0%	0.8986	1175.16	2,412	84.48%	80.0%	0.7615	2,284	1095.25	74.56%
82.5%	0.9743	1211.89	2,476	86.73%	82.5%	0.8399	2,355	1143.37	77.84%
85.0%	1.0631	1248.61	2,533	88.74%	85.0%	0.9138	2,427	1183.21	80.55%
87.5%	1.1677	1285.33	2,589	90.69%	87.5%	1.0044	2,498	1225.22	83.41%
90.0%	1.2942	1322.06	2,641	92.49%	90.0%	1.1299	2,570	1272.83	86.65%
92.5%	1.4537	1358.78	2,690	94.23%	92.5%	1.2947	2,641	1322.19	90.01%
95.0%	1.6727	1395.50	2,741	96.02%	95.0%	1.5285	2,712	1372.86	93.46%
97.5%	2.0243	1432.23	2,794	97.85%	97.5%	1.9536	2,784	1426.55	97.11%
100.0%	3.6574	1468.95	2,855	100.00%	100.0%	3.6574	2,855	1468.95	100.00%

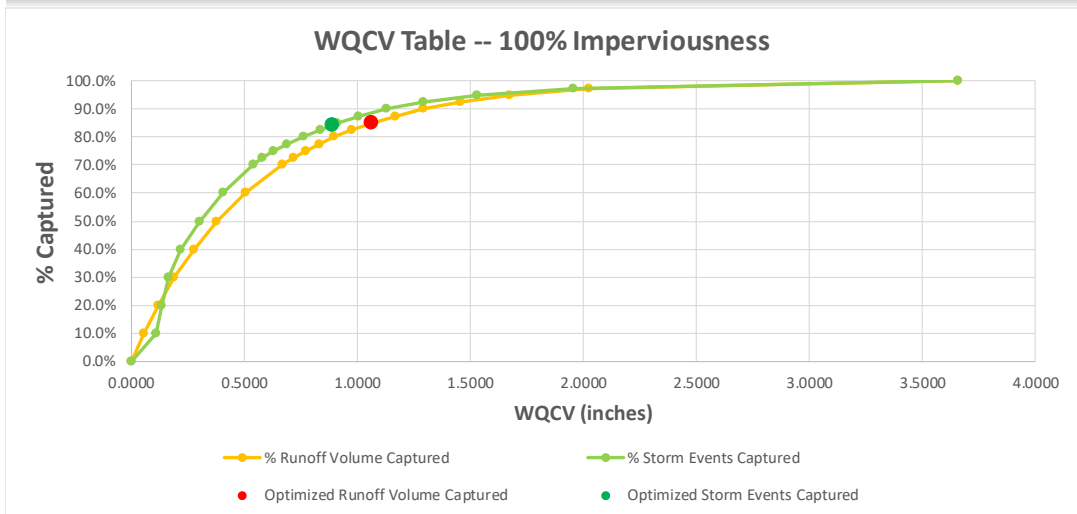

Figure 12. Optimal WQCV Basin Size using WQ-COSM for the NAVARRO MILLS DAM TX US (COOP:416210).



WQCV Table -- 100% Imperviousness									
Optimized Values:									
WQCV Based on Runoff Volume Captured					WQCV Based on Storm Events Captured				
Percent of Volume Captured (%)	WQCV (in)	Volume Captured (in)	Number of Storms Captured	Percent of Storms Captured (%)	Percent of Storms Captured (%)	WQCV (in)	Number of Storms Captured	Volume Captured (%)	Percent of Volume Captured (%)
85.8%	1.0632	803.57	1,780	89.83%	85.7%	0.8931	1,699	755.19	80.59%
Incremental WQCV Values:									
WQCV Based on Runoff Volume Captured					WQCV Based on Storm Events Captured				
Percent of Volume Captured (%)	WQCV (in)	Volume Captured (in)	Number of Storms Captured	Percent of Storms Captured (%)	Percent of Storms Captured (%)	WQCV (in)	Number of Storms Captured	Volume Captured (%)	Percent of Volume Captured (%)
0.0%	0.0000	0.00	0	0.00%	0.0%	0.0000	0	0.00	0.00%
10.0%	0.0539	93.71	0	0.00%	10.0%	0.1101	198	182.84	19.51%
20.0%	0.1134	187.42	224	11.31%	20.0%	0.1352	396	217.75	23.24%
30.0%	0.1831	281.14	711	35.91%	30.0%	0.1603	594	252.66	26.96%
40.0%	0.2674	374.85	957	48.29%	40.0%	0.2100	792	311.65	33.26%
50.0%	0.3690	468.56	1,174	59.24%	50.0%	0.2824	991	389.33	41.55%
60.0%	0.4931	562.27	1,376	69.44%	60.0%	0.3773	1,189	475.30	50.72%
70.0%	0.6530	655.99	1,536	77.55%	70.0%	0.5006	1,387	567.60	60.57%
72.5%	0.7007	679.41	1,577	79.60%	72.5%	0.5473	1,436	596.80	63.68%
75.0%	0.7532	702.84	1,615	81.53%	75.0%	0.5994	1,486	627.90	67.00%
77.5%	0.8122	726.27	1,654	83.47%	77.5%	0.6520	1,535	655.48	69.95%
80.0%	0.8766	749.70	1,691	85.34%	80.0%	0.7117	1,585	684.32	73.02%
82.5%	0.9489	773.13	1,725	87.07%	82.5%	0.7818	1,634	714.57	76.25%
85.0%	1.0335	796.55	1,764	89.03%	85.0%	0.8627	1,684	745.07	79.51%
87.5%	1.1382	819.98	1,814	91.58%	87.5%	0.9678	1,733	778.51	83.07%
90.0%	1.2698	843.41	1,852	93.47%	90.0%	1.0696	1,783	805.08	85.91%
92.5%	1.4451	866.84	1,891	95.45%	92.5%	1.1866	1,832	829.50	88.52%
95.0%	1.6939	890.27	1,918	96.84%	95.0%	1.4007	1,882	861.46	91.93%
97.5%	2.1067	913.69	1,948	98.33%	97.5%	1.8231	1,931	899.23	95.96%
100.0%	3.8275	937.12	1,981	100.00%	100.0%	3.8275	1,981	937.12	100.00%

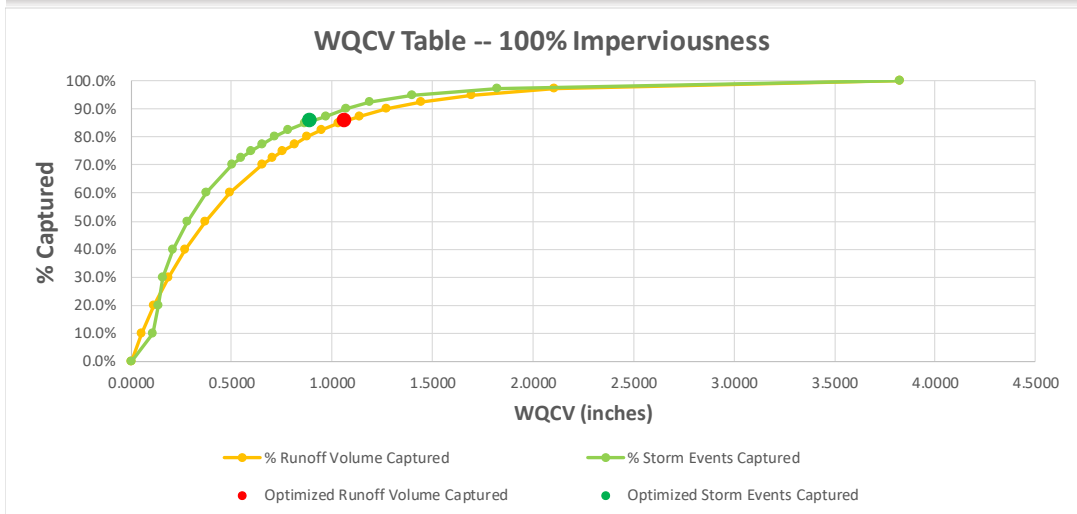

Figure 13. Optimal WQCV Basin Size using WQ-COSM for the SPRINGTOWN 4 S TX US (COOP:418563).

WQCV Table -- 100% Imperviousness									
Optimized Values:									
WQCV Based on Runoff Volume Captured					WQCV Based on Storm Events Captured				
Percent of Volume Captured (%)	WQCV (in)	Volume Captured (in)	Number of Storms Captured	Percent of Storms Captured (%)	Percent of Storms Captured (%)	WQCV (in)	Number of Storms Captured	Volume Captured (%)	Percent of Volume Captured (%)
84.9%	0.9330	874.82	1,912	87.36%	85.4%	0.8639	1,868	850.58	82.52%
Incremental WQCV Values:									
WQCV Based on Runoff Volume Captured					WQCV Based on Storm Events Captured				
Percent of Volume Captured (%)	WQCV (in)	Volume Captured (in)	Number of Storms Captured	Percent of Storms Captured (%)	Percent of Storms Captured (%)	WQCV (in)	Number of Storms Captured	Volume Captured (%)	Percent of Volume Captured (%)
0.0%	0.0000	0.00	0	0.00%	0.0%	0.0000	0	0.00	0.00%
10.0%	0.0520	103.07	2	0.10%	10.0%	0.0974	219	185.96	18.04%
20.0%	0.1090	206.15	308	14.06%	20.0%	0.1261	438	235.72	22.87%
30.0%	0.1740	309.22	681	31.11%	30.0%	0.1682	656	300.74	29.18%
40.0%	0.2502	412.29	983	44.95%	40.0%	0.2216	875	376.16	36.49%
50.0%	0.3409	515.37	1,233	56.36%	50.0%	0.2812	1,094	450.67	43.72%
60.0%	0.4549	618.44	1,440	65.84%	60.0%	0.3824	1,313	555.04	53.85%
70.0%	0.5993	721.52	1,637	74.81%	70.0%	0.5151	1,532	664.75	64.49%
72.5%	0.6422	747.28	1,683	76.93%	72.5%	0.5557	1,586	693.74	67.31%
75.0%	0.6883	773.05	1,729	79.03%	75.0%	0.6030	1,641	723.84	70.23%
77.5%	0.7405	798.82	1,787	81.68%	77.5%	0.6547	1,696	754.28	73.18%
80.0%	0.7984	824.59	1,829	83.59%	80.0%	0.7076	1,750	782.72	75.94%
82.5%	0.8633	850.36	1,867	85.33%	82.5%	0.7567	1,805	806.75	78.27%
85.0%	0.9370	876.13	1,914	87.48%	85.0%	0.8520	1,860	846.16	82.09%
87.5%	1.0221	901.89	1,956	89.39%	87.5%	0.9378	1,915	876.40	85.03%
90.0%	1.1276	927.66	2,010	91.85%	90.0%	1.0482	1,969	908.93	88.18%
92.5%	1.2610	953.43	2,046	93.52%	92.5%	1.1877	2,024	939.98	91.20%
95.0%	1.4416	979.20	2,093	95.65%	95.0%	1.3768	2,079	971.14	94.22%
97.5%	1.7210	1004.97	2,129	97.32%	97.5%	1.7505	2,133	1006.94	97.69%
100.0%	3.2481	1030.74	2,188	100.00%	100.0%	3.2481	2,188	1030.74	100.00%

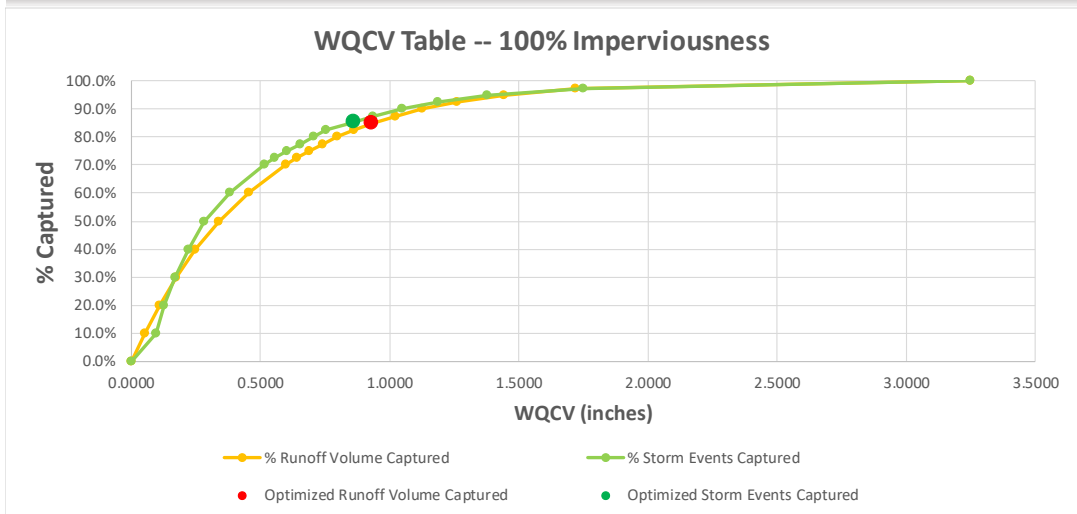

Figure 14. Optimal WQCV Basin Size using WQ-COSM for the STEPHENVILLE 9 NNE TX US (COOP:418623).

WQCV Table -- 100% Imperviousness									
Optimized Values:									
WQCV Based on Runoff Volume Captured					WQCV Based on Storm Events Captured				
Percent of Volume Captured (%)	WQCV (in)	Volume Captured (in)	Number of Storms Captured	Percent of Storms Captured (%)	Percent of Storms Captured (%)	WQCV (in)	Number of Storms Captured	Volume Captured (%)	Percent of Volume Captured (%)
87.7%	1.0632	1402.55	2,975	90.19%	88.7%	0.9781	2,924	1367.22	85.52%
Incremental WQCV Values:									
WQCV Based on Runoff Volume Captured					WQCV Based on Storm Events Captured				
Percent of Volume Captured (%)	WQCV (in)	Volume Captured (in)	Number of Storms Captured	Percent of Storms Captured (%)	Percent of Storms Captured (%)	WQCV (in)	Number of Storms Captured	Volume Captured (%)	Percent of Volume Captured (%)
0.0%	0.0000	0.00	0	0.00%	0.0%	0.0000	0	0.00	0.00%
10.0%	0.0522	159.87	49	1.49%	10.0%	0.1065	330	313.73	19.62%
20.0%	0.1089	319.74	358	10.86%	20.0%	0.1347	660	383.75	24.00%
30.0%	0.1741	479.61	1,094	33.17%	30.0%	0.1630	989	453.78	28.38%
40.0%	0.2523	639.48	1,506	45.65%	40.0%	0.2169	1,319	567.10	35.47%
50.0%	0.3452	799.35	1,820	55.19%	50.0%	0.2936	1,649	711.74	44.52%
60.0%	0.4598	959.22	2,165	65.64%	60.0%	0.3945	1,979	871.63	54.52%
70.0%	0.6043	1119.10	2,466	74.76%	70.0%	0.5193	2,309	1030.80	64.48%
72.5%	0.6486	1159.06	2,544	77.13%	72.5%	0.5637	2,391	1077.59	67.40%
75.0%	0.6955	1199.03	2,621	79.48%	75.0%	0.6087	2,474	1123.06	70.25%
77.5%	0.7489	1239.00	2,697	81.79%	77.5%	0.6555	2,556	1165.24	72.89%
80.0%	0.8100	1278.97	2,777	84.20%	80.0%	0.7074	2,638	1207.97	75.56%
82.5%	0.8792	1318.93	2,852	86.46%	82.5%	0.7654	2,721	1251.34	78.27%
85.0%	0.9595	1358.90	2,913	88.32%	85.0%	0.8309	2,803	1291.93	80.81%
87.5%	1.0536	1398.87	2,969	90.02%	87.5%	0.9207	2,886	1340.48	83.85%
90.0%	1.1688	1438.84	3,041	92.19%	90.0%	1.0523	2,968	1398.36	87.47%
92.5%	1.3232	1478.80	3,106	94.18%	92.5%	1.1842	3,051	1443.71	90.31%
95.0%	1.5416	1518.77	3,171	96.15%	95.0%	1.3990	3,133	1494.40	93.48%
97.5%	1.9007	1558.74	3,233	98.02%	97.5%	1.7950	3,216	1549.51	96.92%
100.0%	4.0827	1598.71	3,298	100.00%	100.0%	4.0827	3,298	1598.71	100.00%

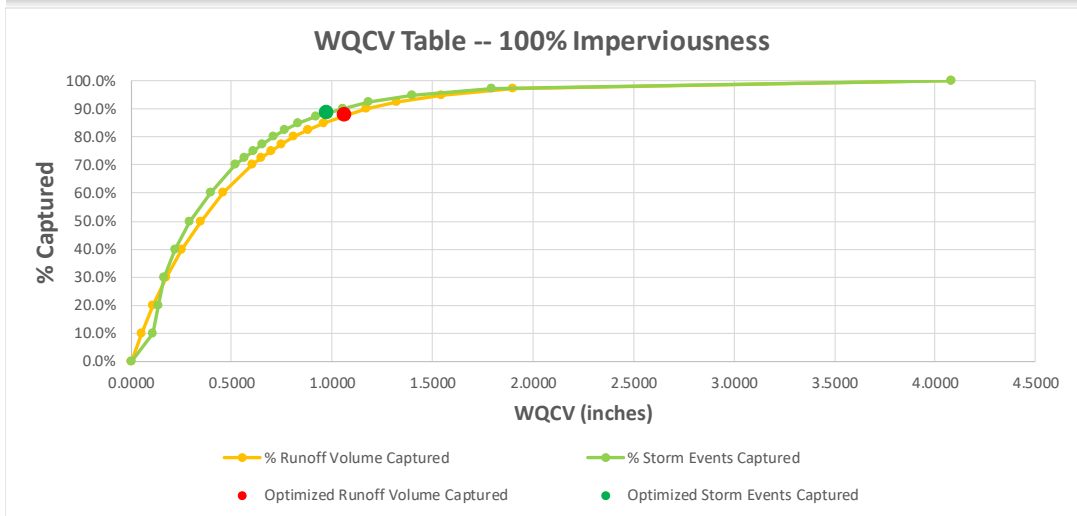

Figure 15. Optimal WQCV Basin Size using WQ-COSM for the WEATHERFORD TX US (COOP:419532).

WQCV Table -- 100% Imperviousness									
Optimized Values:									
WQCV Based on Runoff Volume Captured					WQCV Based on Storm Events Captured				
Percent of Volume Captured (%)	WQCV (in)	Volume Captured (in)	Number of Storms Captured	Percent of Storms Captured (%)	Percent of Storms Captured (%)	WQCV (in)	Number of Storms Captured	Volume Captured (%)	Percent of Volume Captured (%)
86.1%	0.9808	1361.45	2,938	88.48%	84.5%	0.8355	2,805	1285.85	81.28%
Incremental WQCV Values:									
WQCV Based on Runoff Volume Captured					WQCV Based on Storm Events Captured				
Percent of Volume Captured (%)	WQCV (in)	Volume Captured (in)	Number of Storms Captured	Percent of Storms Captured (%)	Percent of Storms Captured (%)	WQCV (in)	Number of Storms Captured	Volume Captured (%)	Percent of Volume Captured (%)
0.0%	0.0000	0.00	0	0.00%	0.0%	0.0000	0	0.00	0.00%
10.0%	0.0527	158.19	11	0.33%	10.0%	0.1005	332	289.67	18.31%
20.0%	0.1108	316.38	450	13.56%	20.0%	0.1296	664	364.70	23.05%
30.0%	0.1773	474.57	1,029	31.00%	30.0%	0.1716	996	462.16	29.22%
40.0%	0.2551	632.76	1,441	43.41%	40.0%	0.2311	1,328	587.54	37.14%
50.0%	0.3461	790.95	1,826	55.00%	50.0%	0.3037	1,660	721.20	45.59%
60.0%	0.4568	949.15	2,155	64.90%	60.0%	0.3983	1,992	869.39	54.96%
70.0%	0.5984	1107.34	2,467	74.32%	70.0%	0.5236	2,324	1029.85	65.10%
72.5%	0.6419	1146.88	2,549	76.79%	72.5%	0.5667	2,407	1076.09	68.02%
75.0%	0.6904	1186.43	2,623	79.00%	75.0%	0.6104	2,490	1118.20	70.69%
77.5%	0.7430	1225.98	2,694	81.15%	77.5%	0.6546	2,573	1158.31	73.22%
80.0%	0.8012	1265.53	2,768	83.38%	80.0%	0.7143	2,656	1205.17	76.18%
82.5%	0.8679	1305.07	2,840	85.54%	82.5%	0.7781	2,739	1249.94	79.01%
85.0%	0.9434	1344.62	2,903	87.44%	85.0%	0.8513	2,822	1295.23	81.88%
87.5%	1.0338	1384.17	2,980	89.75%	87.5%	0.9456	2,905	1345.68	85.07%
90.0%	1.1426	1423.72	3,037	91.49%	90.0%	1.0496	2,988	1390.28	87.89%
92.5%	1.2809	1463.27	3,111	93.69%	92.5%	1.2013	3,071	1441.92	91.15%
95.0%	1.4686	1502.81	3,167	95.38%	95.0%	1.4115	3,154	1491.91	94.31%
97.5%	1.7740	1542.36	3,249	97.87%	97.5%	1.6969	3,237	1535.02	97.04%
100.0%	3.3420	1581.91	3,320	100.00%	100.0%	3.3420	3,320	1581.91	100.00%

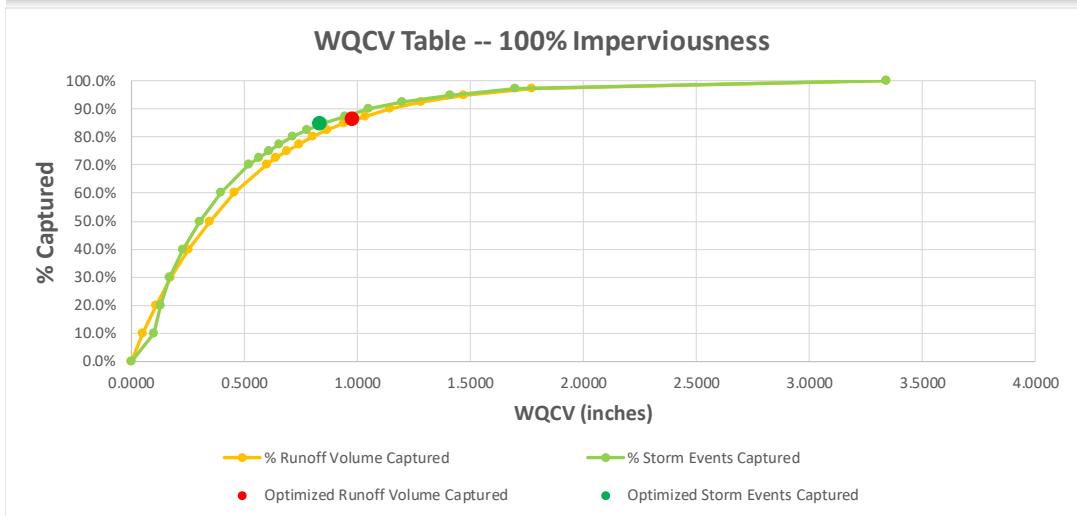

Figure 16. Optimal WQCV Basin Size using WQ-COSM for the ALVORD 3 N TX US (COOP:410206).

WQCV Table -- 100% Imperviousness									
Optimized Values:									
WQCV Based on Runoff Volume Captured					WQCV Based on Storm Events Captured				
Percent of Volume Captured (%)	WQCV (in)	Volume Captured (in)	Number of Storms Captured	Percent of Storms Captured (%)	Percent of Storms Captured (%)	WQCV (in)	Number of Storms Captured	Volume Captured (%)	Percent of Volume Captured (%)
84.4%	0.9968	1149.07	2,359	87.40%	83.0%	0.8373	2,241	1074.57	78.91%
Incremental WQCV Values:									
WQCV Based on Runoff Volume Captured					WQCV Based on Storm Events Captured				
Percent of Volume Captured (%)	WQCV (in)	Volume Captured (in)	Number of Storms Captured	Percent of Storms Captured (%)	Percent of Storms Captured (%)	WQCV (in)	Number of Storms Captured	Volume Captured (%)	Percent of Volume Captured (%)
0.0%	0.0000	0.00	0	0.00%	0.0%	0.0000	0	0.00	0.00%
10.0%	0.0554	136.17	17	0.64%	10.0%	0.1058	270	249.18	18.30%
20.0%	0.1172	272.34	377	13.96%	20.0%	0.1345	540	307.73	22.60%
30.0%	0.1888	408.52	901	33.39%	30.0%	0.1677	810	372.57	27.36%
40.0%	0.2731	544.69	1,216	45.04%	40.0%	0.2299	1,080	478.75	35.16%
50.0%	0.3726	680.86	1,496	55.42%	50.0%	0.3206	1,350	614.38	45.12%
60.0%	0.4937	817.03	1,786	66.16%	60.0%	0.4200	1,619	737.75	54.18%
70.0%	0.6488	953.20	2,023	74.95%	70.0%	0.5506	1,889	871.20	63.98%
72.5%	0.6953	987.25	2,083	77.18%	72.5%	0.5986	1,957	912.31	67.00%
75.0%	0.7460	1021.29	2,146	79.52%	75.0%	0.6497	2,024	953.92	70.05%
77.5%	0.8012	1055.33	2,211	81.92%	77.5%	0.7020	2,092	992.15	72.86%
80.0%	0.8650	1089.38	2,263	83.85%	80.0%	0.7569	2,159	1028.06	75.50%
82.5%	0.9365	1123.42	2,317	85.84%	82.5%	0.8203	2,227	1065.52	78.25%
85.0%	1.0174	1157.46	2,373	87.92%	85.0%	0.9057	2,294	1109.13	81.45%
87.5%	1.1118	1191.50	2,430	90.05%	87.5%	1.0006	2,362	1150.64	84.50%
90.0%	1.2279	1225.55	2,476	91.74%	90.0%	1.1097	2,429	1190.78	87.45%
92.5%	1.3704	1259.59	2,524	93.51%	92.5%	1.2844	2,497	1240.10	91.07%
95.0%	1.5682	1293.63	2,580	95.58%	95.0%	1.5103	2,564	1285.07	94.37%
97.5%	1.8894	1327.68	2,639	97.76%	97.5%	1.8233	2,632	1322.50	97.12%
100.0%	3.1896	1361.72	2,699	100.00%	100.0%	3.1896	2,699	1361.72	100.00%

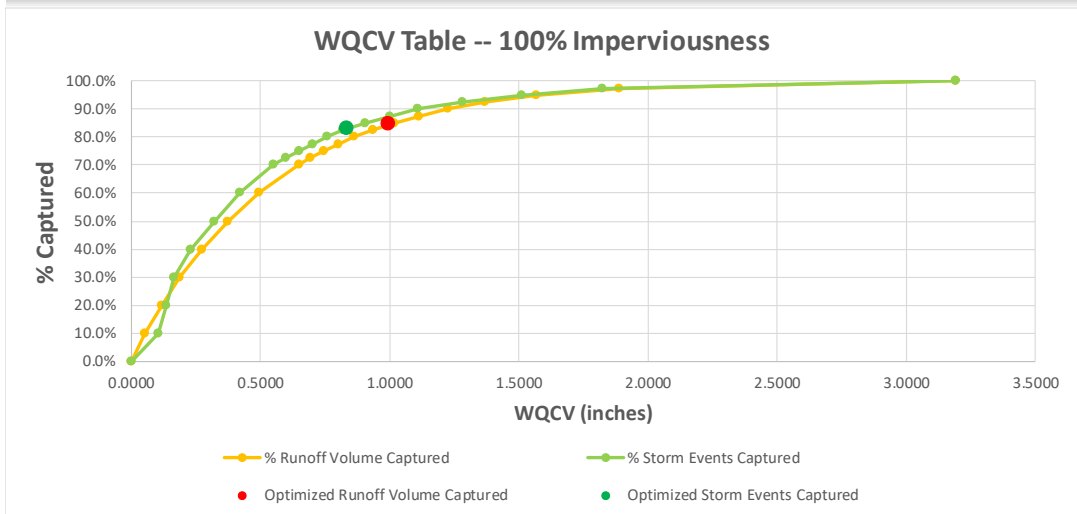

Figure 17. Optimal WQCV Basin Size using WQ-COSM for the BARDWELL DAM TX US (COOP:410518).

WQCV Table -- 100% Imperviousness									
Optimized Values:									
WQCV Based on Runoff Volume Captured					WQCV Based on Storm Events Captured				
Percent of Volume Captured (%)	WQCV (in)	Volume Captured (in)	Number of Storms Captured	Percent of Storms Captured (%)	Percent of Storms Captured (%)	WQCV (in)	Number of Storms Captured	Volume Captured (%)	Percent of Volume Captured (%)
86.2%	1.0406	1335.45	2,380	86.43%	84.3%	0.9635	2,320	1298.78	83.80%
Incremental WQCV Values:									
WQCV Based on Runoff Volume Captured					WQCV Based on Storm Events Captured				
Percent of Volume Captured (%)	WQCV (in)	Volume Captured (in)	Number of Storms Captured	Percent of Storms Captured (%)	Percent of Storms Captured (%)	WQCV (in)	Number of Storms Captured	Volume Captured (%)	Percent of Volume Captured (%)
0.0%	0.0000	0.00	0	0.00%	0.0%	0.0000	0	0.00	0.00%
10.0%	0.0566	154.98	65	2.35%	10.0%	0.1040	275	276.30	17.83%
20.0%	0.1179	309.96	372	13.52%	20.0%	0.1436	551	371.97	24.00%
30.0%	0.1875	464.94	786	28.53%	30.0%	0.1958	826	481.80	31.09%
40.0%	0.2694	619.92	1,133	41.15%	40.0%	0.2605	1,101	604.40	39.00%
50.0%	0.3667	774.90	1,434	52.10%	50.0%	0.3462	1,377	744.07	48.01%
60.0%	0.4870	929.87	1,717	62.38%	60.0%	0.4572	1,652	895.78	57.80%
70.0%	0.6442	1084.85	1,990	72.28%	70.0%	0.6029	1,927	1048.55	67.66%
72.5%	0.6904	1123.60	2,060	74.82%	72.5%	0.6482	1,996	1088.20	70.22%
75.0%	0.7418	1162.34	2,112	76.71%	75.0%	0.6936	2,065	1126.27	72.67%
77.5%	0.7968	1201.09	2,172	78.89%	77.5%	0.7642	2,134	1179.07	76.08%
80.0%	0.8569	1239.83	2,240	81.38%	80.0%	0.8220	2,202	1217.61	78.57%
82.5%	0.9239	1278.58	2,288	83.12%	82.5%	0.9001	2,271	1264.79	81.61%
85.0%	1.0000	1317.32	2,349	85.34%	85.0%	0.9885	2,340	1311.45	84.62%
87.5%	1.0887	1356.07	2,415	87.73%	87.5%	1.0803	2,409	1352.96	87.30%
90.0%	1.1986	1394.81	2,485	90.27%	90.0%	1.1812	2,478	1389.19	89.64%
92.5%	1.3375	1433.56	2,557	92.89%	92.5%	1.3096	2,547	1427.09	92.08%
95.0%	1.5332	1472.30	2,621	95.19%	95.0%	1.5148	2,615	1469.14	94.80%
97.5%	1.8631	1511.05	2,680	97.36%	97.5%	1.8866	2,684	1512.97	97.62%
100.0%	3.5458	1549.79	2,753	100.00%	100.0%	3.5458	2,753	1549.79	100.00%

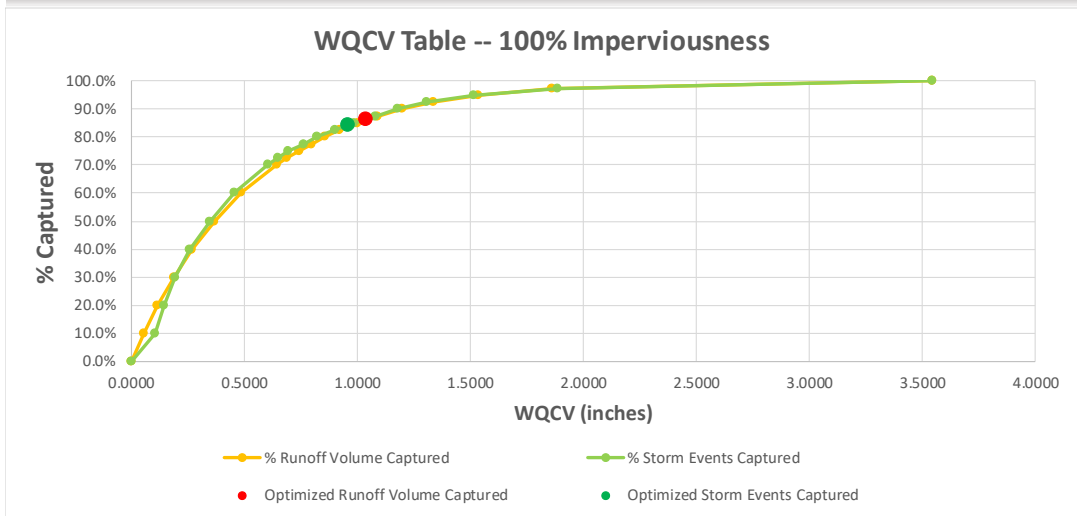

Figure 18. Optimal WQCV Basin Size using WQ-COSM for the BENBROOK DAM TX US (COOP:410691).

WQCV Table -- 100% Imperviousness									
Optimized Values:									
WQCV Based on Runoff Volume Captured					WQCV Based on Storm Events Captured				
Percent of Volume Captured (%)	WQCV (in)	Volume Captured (in)	Number of Storms Captured	Percent of Storms Captured (%)	Percent of Storms Captured (%)	WQCV (in)	Number of Storms Captured	Volume Captured (%)	Percent of Volume Captured (%)
83.2%	0.8931	704.16	1,758	88.52%	86.2%	0.8080	1,713	678.71	80.22%
Incremental WQCV Values:									
WQCV Based on Runoff Volume Captured					WQCV Based on Storm Events Captured				
Percent of Volume Captured (%)	WQCV (in)	Volume Captured (in)	Number of Storms Captured	Percent of Storms Captured (%)	Percent of Storms Captured (%)	WQCV (in)	Number of Storms Captured	Volume Captured (%)	Percent of Volume Captured (%)
0.0%	0.0000	0.00	0	0.00%	0.0%	0.0000	0	0.00	0.00%
10.0%	0.0492	84.60	0	0.00%	10.0%	0.1073	199	175.39	20.73%
20.0%	0.1026	169.21	157	7.88%	20.0%	0.1296	397	204.59	24.18%
30.0%	0.1672	253.81	732	36.86%	30.0%	0.1519	596	233.79	27.63%
40.0%	0.2457	338.42	983	49.48%	40.0%	0.1823	794	270.72	32.00%
50.0%	0.3376	423.02	1,169	58.86%	50.0%	0.2491	993	342.12	40.44%
60.0%	0.4496	507.62	1,362	68.56%	60.0%	0.3504	1,192	433.34	51.22%
70.0%	0.5939	592.23	1,558	78.46%	70.0%	0.4667	1,390	518.84	61.33%
72.5%	0.6400	613.38	1,592	80.16%	72.5%	0.4965	1,440	538.28	63.62%
75.0%	0.6873	634.53	1,626	81.89%	75.0%	0.5336	1,490	559.82	66.17%
77.5%	0.7418	655.68	1,668	83.98%	77.5%	0.5771	1,539	583.21	68.93%
80.0%	0.8023	676.83	1,709	86.05%	80.0%	0.6355	1,589	611.36	72.26%
82.5%	0.8705	697.98	1,748	88.01%	82.5%	0.7033	1,638	640.73	75.73%
85.0%	0.9497	719.14	1,783	89.78%	85.0%	0.7689	1,688	665.98	78.72%
87.5%	1.0422	740.29	1,820	91.66%	87.5%	0.8486	1,738	691.88	81.78%
90.0%	1.1560	761.44	1,854	93.35%	90.0%	0.9602	1,787	721.63	85.29%
92.5%	1.3021	782.59	1,884	94.88%	92.5%	1.0912	1,837	750.00	88.65%
95.0%	1.5004	803.74	1,912	96.27%	95.0%	1.3165	1,887	784.34	92.71%
97.5%	1.8164	824.89	1,949	98.13%	97.5%	1.6658	1,936	816.82	96.55%
100.0%	3.3172	846.04	1,986	100.00%	100.0%	3.3172	1,986	846.04	100.00%

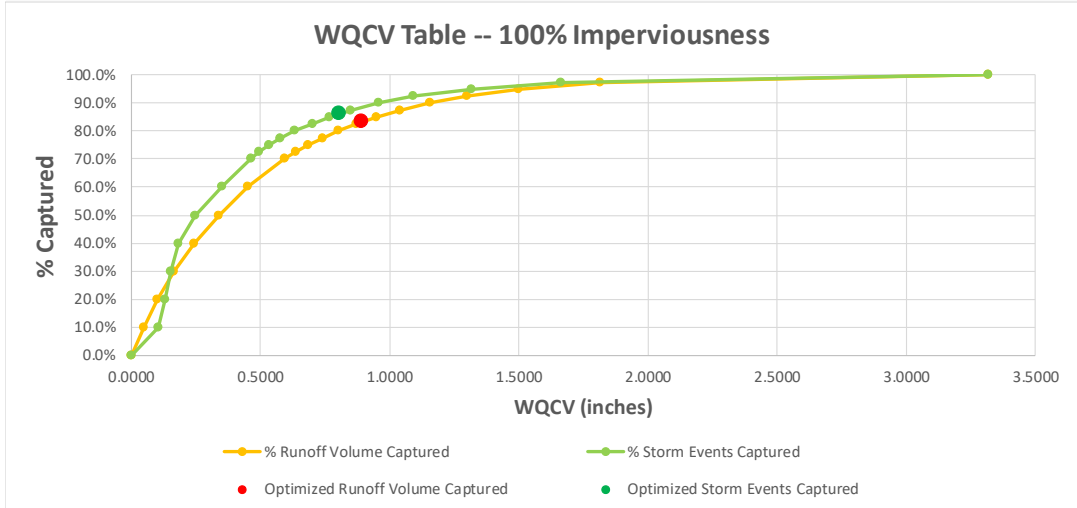

Figure 19. Optimal WQCV Basin Size using WQ-COSM for the BURLESON TX US (COOP:411246).

WQCV Table -- 100% Imperviousness									
Optimized Values:									
WQCV Based on Runoff Volume Captured					WQCV Based on Storm Events Captured				
Percent of Volume Captured (%)	WQCV (in)	Volume Captured (in)	Number of Storms Captured	Percent of Storms Captured (%)	Percent of Storms Captured (%)	WQCV (in)	Number of Storms Captured	Volume Captured (%)	Percent of Volume Captured (%)
85.9%	1.0964	1758.82	3,246	88.42%	88.4%	1.0964	3,246	1758.82	85.89%
Incremental WQCV Values:									
WQCV Based on Runoff Volume Captured					WQCV Based on Storm Events Captured				
Percent of Volume Captured (%)	WQCV (in)	Volume Captured (in)	Number of Storms Captured	Percent of Storms Captured (%)	Percent of Storms Captured (%)	WQCV (in)	Number of Storms Captured	Volume Captured (%)	Percent of Volume Captured (%)
0.0%	0.0000	0.00	0	0.00%	0.0%	0.0000	0	0.00	0.00%
10.0%	0.0590	204.78	392	10.66%	10.0%	0.0553	367	192.02	9.38%
20.0%	0.1242	409.57	822	22.39%	20.0%	0.1109	734	371.12	18.12%
30.0%	0.1990	614.35	1,277	34.80%	30.0%	0.1667	1,101	531.98	25.98%
40.0%	0.2872	819.14	1,691	46.08%	40.0%	0.2370	1,468	706.40	34.49%
50.0%	0.3928	1023.92	2,054	55.94%	50.0%	0.3250	1,836	896.84	43.79%
60.0%	0.5193	1228.71	2,389	65.08%	60.0%	0.4459	2,203	1115.77	54.49%
70.0%	0.6807	1433.49	2,718	74.05%	70.0%	0.6102	2,570	1352.16	66.03%
72.5%	0.7293	1484.69	2,805	76.42%	72.5%	0.6538	2,661	1402.77	68.50%
75.0%	0.7812	1535.89	2,885	78.60%	75.0%	0.6971	2,753	1452.27	70.92%
77.5%	0.8401	1587.08	2,965	80.77%	77.5%	0.7550	2,845	1510.06	73.74%
80.0%	0.9047	1638.28	3,051	83.11%	80.0%	0.8188	2,937	1568.91	76.61%
82.5%	0.9779	1689.47	3,143	85.61%	82.5%	0.8880	3,029	1626.29	79.41%
85.0%	1.0623	1740.67	3,213	87.53%	85.0%	0.9562	3,120	1675.24	81.80%
87.5%	1.1623	1791.87	3,301	89.92%	87.5%	1.0611	3,212	1740.01	84.97%
90.0%	1.2864	1843.06	3,373	91.87%	90.0%	1.1671	3,304	1794.01	87.60%
92.5%	1.4417	1894.26	3,441	93.74%	92.5%	1.3329	3,396	1859.86	90.82%
95.0%	1.6513	1945.45	3,514	95.74%	95.0%	1.5615	3,487	1925.74	94.04%
97.5%	1.9910	1996.65	3,585	97.66%	97.5%	1.9584	3,579	1993.02	97.32%
100.0%	4.2103	2047.85	3,671	100.00%	100.0%	4.2103	3,671	2047.85	100.00%

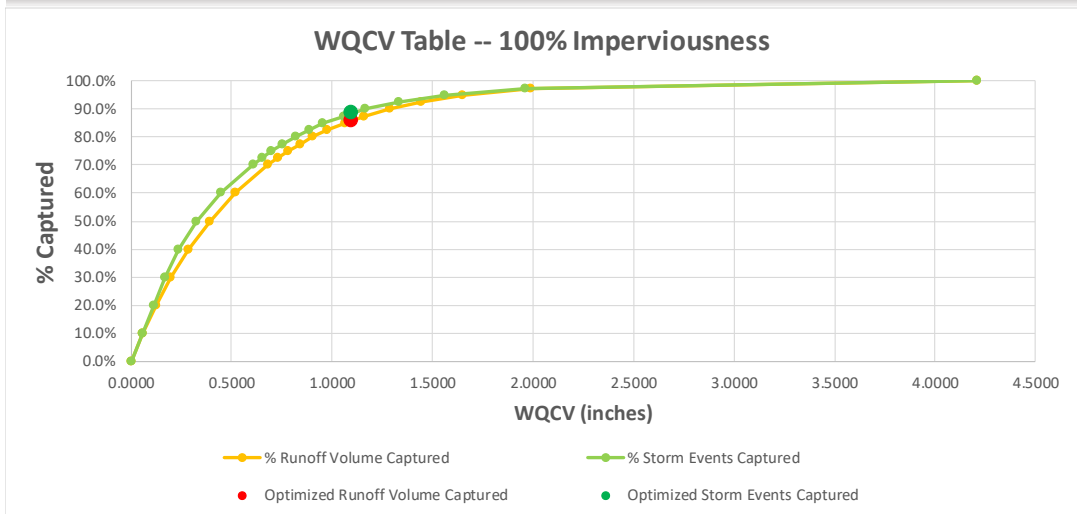

Figure 20. Optimal WQCV Basin Size using WQ-COSM for the COMMERCE 4 SW TX US (COOP:411921).



WQCV Table -- 100% Imperviousness									
Optimized Values:									
WQCV Based on Runoff Volume Captured					WQCV Based on Storm Events Captured				
Percent of Volume Captured (%)	WQCV (in)	Volume Captured (in)	Number of Storms Captured	Percent of Storms Captured (%)	Percent of Storms Captured (%)	WQCV (in)	Number of Storms Captured	Volume Captured (%)	Percent of Volume Captured (%)
86.6%	1.0286	1415.38	2,926	89.56%	87.6%	0.9525	2,862	1381.09	84.46%
Incremental WQCV Values:									
WQCV Based on Runoff Volume Captured					WQCV Based on Storm Events Captured				
Percent of Volume Captured (%)	WQCV (in)	Volume Captured (in)	Number of Storms Captured	Percent of Storms Captured (%)	Percent of Storms Captured (%)	WQCV (in)	Number of Storms Captured	Volume Captured (%)	Percent of Volume Captured (%)
0.0%	0.0000	0.00	0	0.00%	0.0%	0.0000	0	0.00	0.00%
10.0%	0.0532	163.52	35	1.07%	10.0%	0.1025	327	303.10	18.54%
20.0%	0.1117	327.03	423	12.94%	20.0%	0.1336	653	384.45	23.51%
30.0%	0.1783	490.55	1,001	30.65%	30.0%	0.1746	980	482.50	29.51%
40.0%	0.2567	654.06	1,412	43.22%	40.0%	0.2319	1,307	607.07	37.13%
50.0%	0.3499	817.58	1,778	54.44%	50.0%	0.3099	1,634	753.02	46.05%
60.0%	0.4633	981.09	2,117	64.80%	60.0%	0.4061	1,960	902.62	55.20%
70.0%	0.6117	1144.61	2,448	74.94%	70.0%	0.5284	2,287	1058.99	64.76%
72.5%	0.6580	1185.49	2,521	77.17%	72.5%	0.5694	2,369	1101.74	67.38%
75.0%	0.7073	1226.37	2,592	79.34%	75.0%	0.6129	2,450	1145.64	70.06%
77.5%	0.7610	1267.25	2,660	81.42%	77.5%	0.6648	2,532	1191.46	72.87%
80.0%	0.8225	1308.13	2,720	83.25%	80.0%	0.7243	2,614	1239.34	75.79%
82.5%	0.8909	1349.00	2,798	85.65%	82.5%	0.7973	2,695	1291.39	78.98%
85.0%	0.9705	1389.88	2,878	88.10%	85.0%	0.8733	2,777	1338.82	81.88%
87.5%	1.0659	1430.76	2,954	90.43%	87.5%	0.9494	2,859	1379.59	84.37%
90.0%	1.1875	1471.64	3,018	92.37%	90.0%	1.0474	2,940	1423.13	87.03%
92.5%	1.3491	1512.52	3,086	94.46%	92.5%	1.1967	3,022	1474.43	90.17%
95.0%	1.5663	1553.40	3,134	95.92%	95.0%	1.4070	3,104	1524.61	93.24%
97.5%	1.8860	1594.28	3,193	97.72%	97.5%	1.8180	3,185	1587.78	97.10%
100.0%	3.6574	1635.16	3,267	100.00%	100.0%	3.6574	3,267	1635.16	100.00%

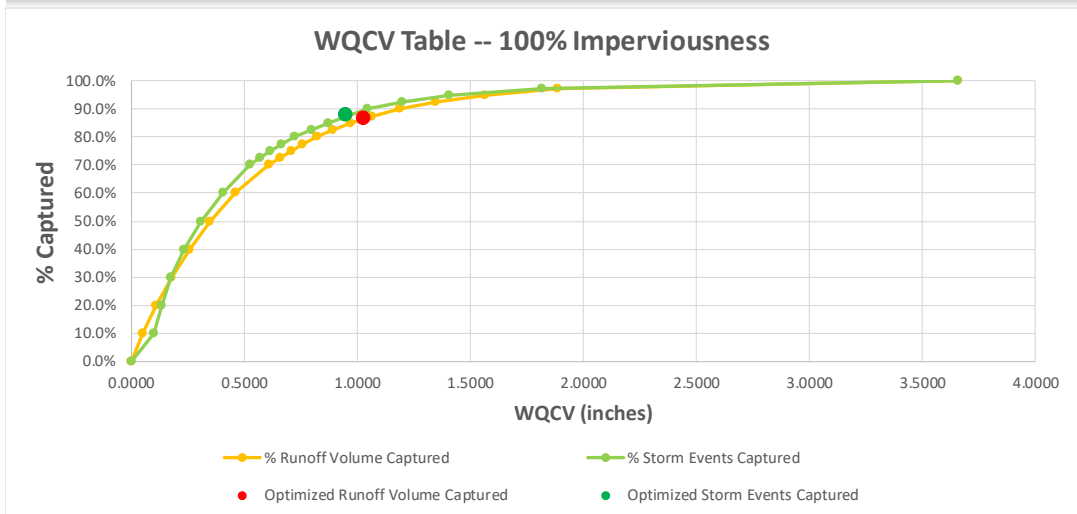

Figure 21. Optimal WQCV Basin Size using WQ-COSM for the CRESSON TX US (COOP:412096).

WQCV Table -- 100% Imperviousness									
Optimized Values:									
WQCV Based on Runoff Volume Captured					WQCV Based on Storm Events Captured				
Percent of Volume Captured (%)	WQCV (in)	Volume Captured (in)	Number of Storms Captured	Percent of Storms Captured (%)	Percent of Storms Captured (%)	WQCV (in)	Number of Storms Captured	Volume Captured (%)	Percent of Volume Captured (%)
86.2%	1.0023	973.06	1,587	85.69%	83.6%	0.9281	1,549	947.10	83.94%
Incremental WQCV Values:									
WQCV Based on Runoff Volume Captured					WQCV Based on Storm Events Captured				
Percent of Volume Captured (%)	WQCV (in)	Volume Captured (in)	Number of Storms Captured	Percent of Storms Captured (%)	Percent of Storms Captured (%)	WQCV (in)	Number of Storms Captured	Volume Captured (%)	Percent of Volume Captured (%)
0.0%	0.0000	0.00	0	0.00%	0.0%	0.0000	0	0.00	0.00%
10.0%	0.0570	112.83	35	1.87%	10.0%	0.1072	185	205.71	18.23%
20.0%	0.1184	225.66	233	12.57%	20.0%	0.1515	370	284.16	25.18%
30.0%	0.1872	338.49	480	25.94%	30.0%	0.2116	556	375.66	33.29%
40.0%	0.2672	451.32	695	37.55%	40.0%	0.2864	741	476.52	42.23%
50.0%	0.3608	564.16	895	48.32%	50.0%	0.3771	926	582.09	51.59%
60.0%	0.4748	676.99	1,086	58.64%	60.0%	0.4919	1,111	692.19	61.35%
70.0%	0.6187	789.82	1,280	69.13%	70.0%	0.6351	1,296	800.69	70.96%
72.5%	0.6612	818.03	1,322	71.39%	72.5%	0.6820	1,343	830.56	73.61%
75.0%	0.7094	846.23	1,370	73.97%	75.0%	0.7284	1,389	857.13	75.97%
77.5%	0.7613	874.44	1,420	76.66%	77.5%	0.7788	1,435	883.04	78.26%
80.0%	0.8190	902.65	1,471	79.42%	80.0%	0.8326	1,482	908.44	80.51%
82.5%	0.8852	930.86	1,523	82.26%	82.5%	0.8908	1,528	933.24	82.71%
85.0%	0.9602	959.07	1,566	84.57%	85.0%	0.9759	1,574	964.42	85.47%
87.5%	1.0467	987.27	1,608	86.81%	87.5%	1.0806	1,621	996.92	88.36%
90.0%	1.1496	1015.48	1,648	88.98%	90.0%	1.1949	1,667	1026.71	91.00%
92.5%	1.2764	1043.69	1,698	91.70%	92.5%	1.3267	1,713	1052.67	93.30%
95.0%	1.4589	1071.90	1,749	94.44%	95.0%	1.5018	1,759	1077.02	95.45%
97.5%	1.7613	1100.10	1,798	97.08%	97.5%	1.8401	1,806	1104.93	97.93%
100.0%	3.3411	1128.31	1,852	100.00%	100.0%	3.3411	1,852	1128.31	100.00%

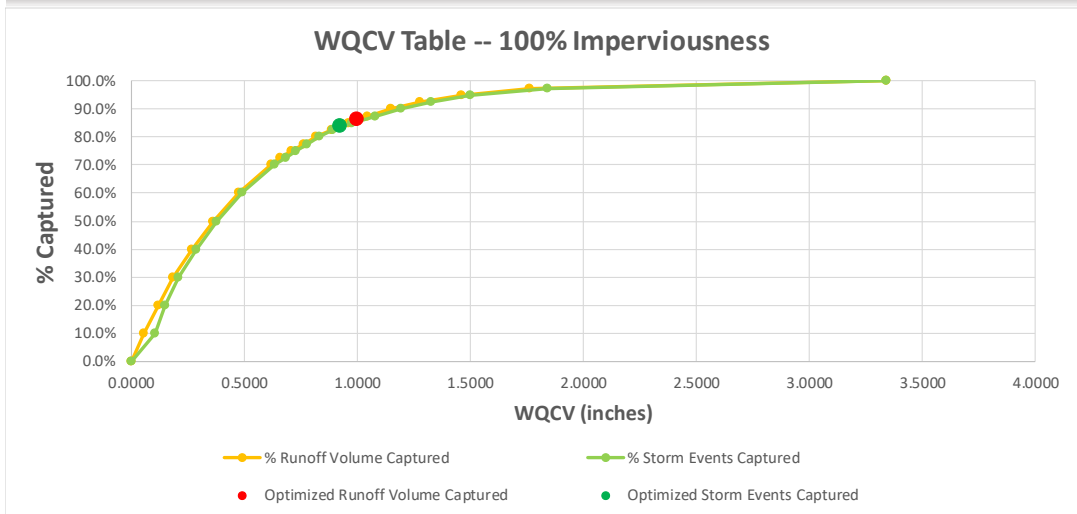

Figure 22. Optimal WQCV Basin Size using WQ-COSM for the DAL FTW WSCMO AIRPORT TX US (COOP:412242).

WQCV Table -- 100% Imperviousness									
Optimized Values:									
WQCV Based on Runoff Volume Captured					WQCV Based on Storm Events Captured				
Percent of Volume Captured (%)	WQCV (in)	Volume Captured (in)	Number of Storms Captured	Percent of Storms Captured (%)	Percent of Storms Captured (%)	WQCV (in)	Number of Storms Captured	Volume Captured (%)	Percent of Volume Captured (%)
84.0%	1.0107	1684.25	3,102	86.60%	84.5%	0.9229	3,026	1629.08	81.29%
Incremental WQCV Values:									
WQCV Based on Runoff Volume Captured					WQCV Based on Storm Events Captured				
Percent of Volume Captured (%)	WQCV (in)	Volume Captured (in)	Number of Storms Captured	Percent of Storms Captured (%)	Percent of Storms Captured (%)	WQCV (in)	Number of Storms Captured	Volume Captured (%)	Percent of Volume Captured (%)
0.0%	0.0000	0.00	0	0.00%	0.0%	0.0000	0	0.00	0.00%
10.0%	0.0569	200.40	305	8.52%	10.0%	0.0668	358	235.26	11.74%
20.0%	0.1189	400.80	687	19.18%	20.0%	0.1232	716	413.30	20.62%
30.0%	0.1894	601.20	1,155	32.23%	30.0%	0.1747	1,075	565.04	28.20%
40.0%	0.2734	801.60	1,589	44.37%	40.0%	0.2415	1,433	727.92	36.32%
50.0%	0.3750	1002.00	1,963	54.81%	50.0%	0.3246	1,791	906.40	45.23%
60.0%	0.4993	1202.40	2,335	65.17%	60.0%	0.4405	2,149	1115.37	55.66%
70.0%	0.6602	1402.81	2,682	74.87%	70.0%	0.5677	2,507	1294.56	64.60%
72.5%	0.7073	1452.91	2,759	77.02%	72.5%	0.6104	2,597	1348.24	67.28%
75.0%	0.7616	1503.01	2,837	79.20%	75.0%	0.6631	2,687	1405.89	70.15%
77.5%	0.8201	1553.11	2,914	81.36%	77.5%	0.7192	2,776	1463.91	73.05%
80.0%	0.8844	1603.21	2,991	83.50%	80.0%	0.7817	2,866	1521.56	75.93%
82.5%	0.9589	1653.31	3,059	85.39%	82.5%	0.8536	2,955	1579.55	78.82%
85.0%	1.0436	1703.41	3,129	87.35%	85.0%	0.9434	3,045	1642.89	81.98%
87.5%	1.1420	1753.51	3,206	89.49%	87.5%	1.0501	3,134	1707.21	85.19%
90.0%	1.2636	1803.61	3,280	91.58%	90.0%	1.1705	3,224	1765.78	88.11%
92.5%	1.4147	1853.71	3,355	93.66%	92.5%	1.3234	3,313	1825.24	91.08%
95.0%	1.6237	1903.81	3,422	95.54%	95.0%	1.5598	3,403	1890.35	94.33%
97.5%	1.9379	1953.91	3,483	97.24%	97.5%	1.9719	3,492	1957.56	97.68%
100.0%	3.6035	2004.01	3,582	100.00%	100.0%	3.6035	3,582	2004.01	100.00%

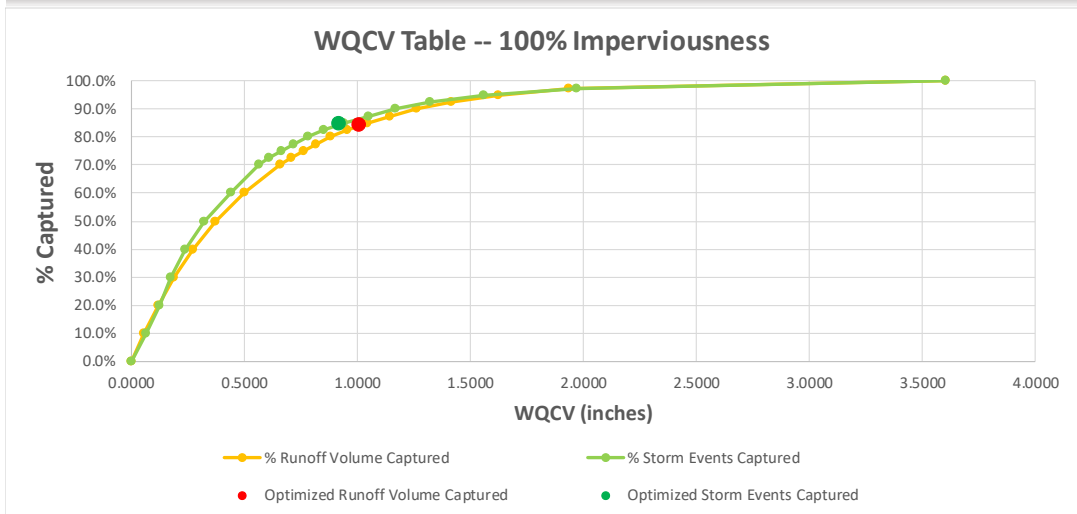

Figure 23. Optimal WQCV Basin Size using WQ-COSM for the DALLAS FAA AIRPORT TX US (COOP:412244).

WQCV Table -- 100% Imperviousness									
Optimized Values:									
WQCV Based on Runoff Volume Captured					WQCV Based on Storm Events Captured				
Percent of Volume Captured (%)	WQCV (in)	Volume Captured (in)	Number of Storms Captured	Percent of Storms Captured (%)	Percent of Storms Captured (%)	WQCV (in)	Number of Storms Captured	Volume Captured (%)	Percent of Volume Captured (%)
87.3%	1.0566	1475.31	2,878	89.21%	87.1%	0.9720	2,810	1435.97	85.01%
Incremental WQCV Values:									
WQCV Based on Runoff Volume Captured					WQCV Based on Storm Events Captured				
Percent of Volume Captured (%)	WQCV (in)	Volume Captured (in)	Number of Storms Captured	Percent of Storms Captured (%)	Percent of Storms Captured (%)	WQCV (in)	Number of Storms Captured	Volume Captured (%)	Percent of Volume Captured (%)
0.0%	0.0000	0.00	0	0.00%	0.0%	0.0000	0	0.00	0.00%
10.0%	0.0545	168.92	92	2.86%	10.0%	0.1029	323	309.65	18.33%
20.0%	0.1138	337.83	429	13.29%	20.0%	0.1360	645	395.26	23.40%
30.0%	0.1813	506.75	1,031	31.96%	30.0%	0.1692	968	480.98	28.47%
40.0%	0.2615	675.66	1,439	44.60%	40.0%	0.2306	1,290	612.23	36.24%
50.0%	0.3572	844.58	1,761	54.60%	50.0%	0.3109	1,613	765.49	45.32%
60.0%	0.4731	1013.50	2,062	63.91%	60.0%	0.4207	1,936	942.76	55.81%
70.0%	0.6186	1182.41	2,367	73.39%	70.0%	0.5628	2,258	1122.98	66.48%
72.5%	0.6620	1224.64	2,447	75.85%	72.5%	0.6030	2,339	1167.21	69.10%
75.0%	0.7111	1266.87	2,524	78.23%	75.0%	0.6470	2,420	1210.04	71.64%
77.5%	0.7634	1309.10	2,599	80.57%	77.5%	0.6949	2,500	1253.64	74.22%
80.0%	0.8249	1351.33	2,667	82.68%	80.0%	0.7503	2,581	1298.73	76.89%
82.5%	0.8936	1393.56	2,738	84.87%	82.5%	0.8196	2,661	1347.69	79.78%
85.0%	0.9717	1435.79	2,809	87.08%	85.0%	0.8977	2,742	1395.94	82.64%
87.5%	1.0629	1478.01	2,883	89.37%	87.5%	0.9878	2,823	1443.92	85.48%
90.0%	1.1738	1520.24	2,955	91.61%	90.0%	1.0891	2,903	1489.19	88.16%
92.5%	1.3247	1562.47	3,033	94.00%	92.5%	1.2223	2,984	1535.16	90.88%
95.0%	1.5329	1604.70	3,091	95.83%	95.0%	1.4321	3,065	1586.50	93.92%
97.5%	1.9102	1646.93	3,156	97.82%	97.5%	1.8287	3,145	1640.01	97.09%
100.0%	4.0572	1689.16	3,226	100.00%	100.0%	4.0572	3,226	1689.16	100.00%

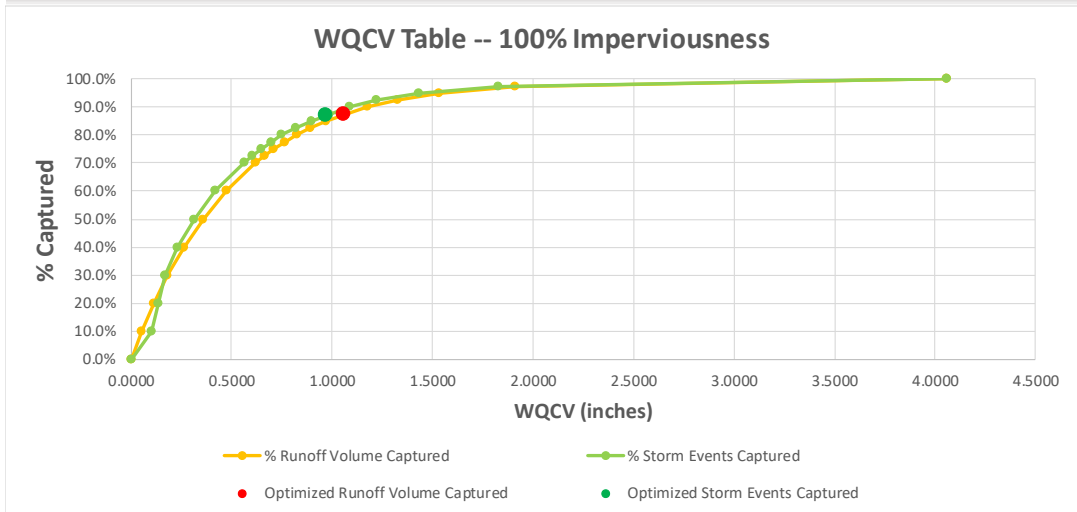

Figure 24. Optimal WQCV Basin Size using WQ-COSM for the DENTON 2 SE TX US (COOP:412404).

WQCV Table -- 100% Imperviousness									
Optimized Values:									
WQCV Based on Runoff Volume Captured					WQCV Based on Storm Events Captured				
Percent of Volume Captured (%)	WQCV (in)	Volume Captured (in)	Number of Storms Captured	Percent of Storms Captured (%)	Percent of Storms Captured (%)	WQCV (in)	Number of Storms Captured	Volume Captured (%)	Percent of Volume Captured (%)
84.1%	0.9965	1475.66	2,697	86.39%	86.4%	0.9965	2,697	1475.66	84.12%
Incremental WQCV Values:									
WQCV Based on Runoff Volume Captured					WQCV Based on Storm Events Captured				
Percent of Volume Captured (%)	WQCV (in)	Volume Captured (in)	Number of Storms Captured	Percent of Storms Captured (%)	Percent of Storms Captured (%)	WQCV (in)	Number of Storms Captured	Volume Captured (%)	Percent of Volume Captured (%)
0.0%	0.0000	0.00	0	0.00%	0.0%	0.0000	0	0.00	0.00%
10.0%	0.0582	175.43	281	9.00%	10.0%	0.0647	312	195.01	11.12%
20.0%	0.1216	350.86	615	19.69%	20.0%	0.1233	624	355.21	20.25%
30.0%	0.1930	526.28	992	31.77%	30.0%	0.1803	937	498.82	28.43%
40.0%	0.2766	701.71	1,336	42.81%	40.0%	0.2521	1,249	654.00	37.28%
50.0%	0.3761	877.14	1,654	52.99%	50.0%	0.3466	1,561	830.82	47.36%
60.0%	0.4972	1052.57	1,978	63.36%	60.0%	0.4503	1,873	989.75	56.42%
70.0%	0.6516	1228.00	2,285	73.20%	70.0%	0.5973	2,185	1173.11	66.87%
72.5%	0.6970	1271.85	2,365	75.77%	72.5%	0.6396	2,263	1216.18	69.33%
75.0%	0.7500	1315.71	2,441	78.20%	75.0%	0.6829	2,342	1258.65	71.75%
77.5%	0.8070	1359.57	2,512	80.47%	77.5%	0.7348	2,420	1303.14	74.28%
80.0%	0.8694	1403.42	2,577	82.54%	80.0%	0.7930	2,498	1349.66	76.94%
82.5%	0.9425	1447.28	2,651	84.92%	82.5%	0.8681	2,576	1402.68	79.96%
85.0%	1.0270	1491.14	2,722	87.18%	85.0%	0.9450	2,654	1448.80	82.59%
87.5%	1.1273	1535.00	2,798	89.64%	87.5%	1.0395	2,732	1497.46	85.36%
90.0%	1.2509	1578.85	2,856	91.47%	90.0%	1.1508	2,810	1543.69	88.00%
92.5%	1.4041	1622.71	2,923	93.62%	92.5%	1.3261	2,888	1601.85	91.31%
95.0%	1.6249	1666.57	2,991	95.81%	95.0%	1.5161	2,966	1647.10	93.89%
97.5%	1.9942	1710.42	3,052	97.76%	97.5%	1.9348	3,044	1705.10	97.20%
100.0%	3.7260	1754.28	3,122	100.00%	100.0%	3.7260	3,122	1754.28	100.00%

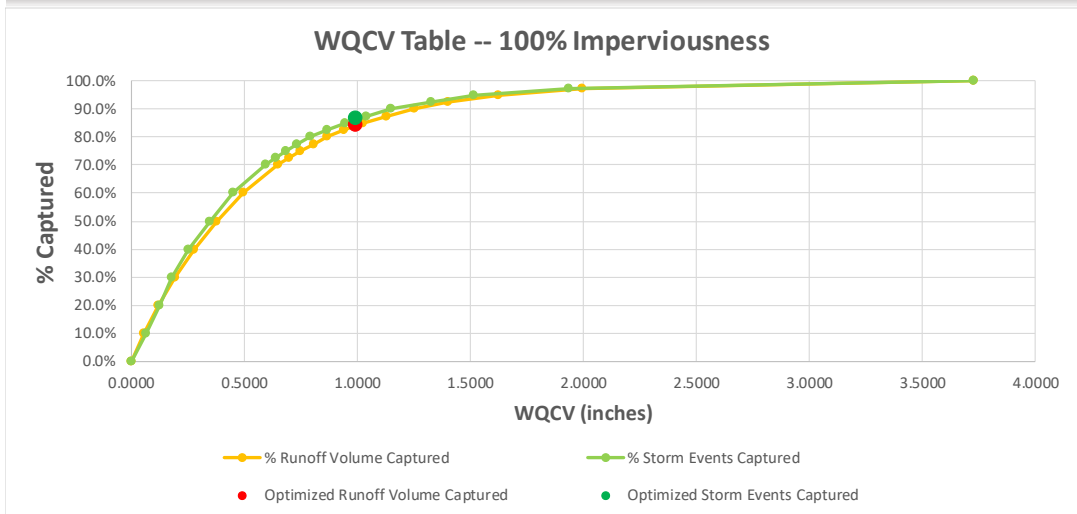

Figure 25. Optimal WQCV Basin Size using WQ-COSM for the FERRIS TX US (COOP:413133).

WQCV Table -- 100% Imperviousness									
Optimized Values:									
WQCV Based on Runoff Volume Captured					WQCV Based on Storm Events Captured				
Percent of Volume Captured (%)	WQCV (in)	Volume Captured (in)	Number of Storms Captured	Percent of Storms Captured (%)	Percent of Storms Captured (%)	WQCV (in)	Number of Storms Captured	Volume Captured (%)	Percent of Volume Captured (%)
84.9%	0.9525	1441.85	2,934	87.31%	85.6%	0.8763	2,878	1400.38	82.41%
Incremental WQCV Values:									
WQCV Based on Runoff Volume Captured					WQCV Based on Storm Events Captured				
Percent of Volume Captured (%)	WQCV (in)	Volume Captured (in)	Number of Storms Captured	Percent of Storms Captured (%)	Percent of Storms Captured (%)	WQCV (in)	Number of Storms Captured	Volume Captured (%)	Percent of Volume Captured (%)
0.0%	0.0000	0.00	0	0.00%	0.0%	0.0000	0	0.00	0.00%
10.0%	0.0525	169.93	42	1.25%	10.0%	0.1020	336	317.95	18.71%
20.0%	0.1099	339.85	420	12.51%	20.0%	0.1335	672	405.34	23.85%
30.0%	0.1750	509.78	1,004	29.89%	30.0%	0.1756	1,008	511.18	30.08%
40.0%	0.2520	679.70	1,432	42.61%	40.0%	0.2341	1,344	644.61	37.93%
50.0%	0.3449	849.63	1,832	54.51%	50.0%	0.3027	1,680	779.15	45.85%
60.0%	0.4586	1019.56	2,181	64.92%	60.0%	0.4008	2,016	937.57	55.18%
70.0%	0.6045	1189.48	2,494	74.23%	70.0%	0.5321	2,352	1110.69	65.36%
72.5%	0.6491	1231.96	2,567	76.39%	72.5%	0.5748	2,436	1157.21	68.10%
75.0%	0.6960	1274.44	2,643	78.65%	75.0%	0.6196	2,520	1204.36	70.88%
77.5%	0.7492	1316.93	2,734	81.37%	77.5%	0.6725	2,604	1253.88	73.79%
80.0%	0.8100	1359.41	2,813	83.73%	80.0%	0.7224	2,688	1295.51	76.24%
82.5%	0.8789	1401.89	2,880	85.70%	82.5%	0.7754	2,772	1336.10	78.63%
85.0%	0.9574	1444.37	2,937	87.40%	85.0%	0.8494	2,856	1384.87	81.50%
87.5%	1.0469	1486.85	3,000	89.28%	87.5%	0.9622	2,940	1446.81	85.14%
90.0%	1.1536	1529.33	3,063	91.15%	90.0%	1.0845	3,024	1502.78	88.44%
92.5%	1.2856	1571.81	3,131	93.19%	92.5%	1.2406	3,108	1558.39	91.71%
95.0%	1.4654	1614.30	3,201	95.28%	95.0%	1.4396	3,192	1609.26	94.70%
97.5%	1.7687	1656.78	3,279	97.59%	97.5%	1.7525	3,276	1655.22	97.41%
100.0%	3.5050	1699.26	3,360	100.00%	100.0%	3.5050	3,360	1699.26	100.00%

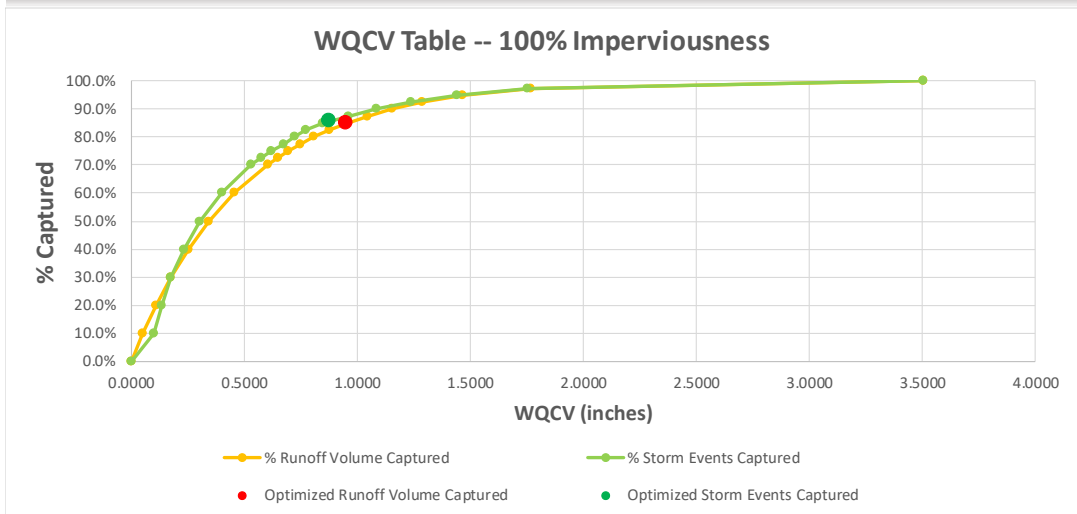

Figure 26. Optimal WQCV Basin Size using WQ-COSM for the FORT WORTH MEACHAM FIELD TX US (COOP:413284).

WQCV Table -- 100% Imperviousness									
Optimized Values:									
WQCV Based on Runoff Volume Captured					WQCV Based on Storm Events Captured				
Percent of Volume Captured (%)	WQCV (in)	Volume Captured (in)	Number of Storms Captured	Percent of Storms Captured (%)	Percent of Storms Captured (%)	WQCV (in)	Number of Storms Captured	Volume Captured (%)	Percent of Volume Captured (%)
86.1%	1.0047	1228.51	2,797	89.09%	85.4%	0.8559	2,682	1158.70	81.24%
Incremental WQCV Values:									
WQCV Based on Runoff Volume Captured					WQCV Based on Storm Events Captured				
Percent of Volume Captured (%)	WQCV (in)	Volume Captured (in)	Number of Storms Captured	Percent of Storms Captured (%)	Percent of Storms Captured (%)	WQCV (in)	Number of Storms Captured	Volume Captured (%)	Percent of Volume Captured (%)
0.0%	0.0000	0.00	0	0.00%	0.0%	0.0000	0	0.00	0.00%
10.0%	0.0514	142.62	6	0.20%	10.0%	0.0998	314	265.01	18.58%
20.0%	0.1086	285.25	419	13.35%	20.0%	0.1259	628	325.35	22.81%
30.0%	0.1751	427.87	1,067	33.99%	30.0%	0.1550	942	389.96	27.34%
40.0%	0.2554	570.50	1,501	47.83%	40.0%	0.2053	1,256	484.90	34.00%
50.0%	0.3513	713.12	1,850	58.93%	50.0%	0.2718	1,570	596.93	41.85%
60.0%	0.4687	855.74	2,158	68.75%	60.0%	0.3617	1,883	727.65	51.02%
70.0%	0.6182	998.37	2,404	76.58%	70.0%	0.4864	2,197	874.42	61.31%
72.5%	0.6618	1034.02	2,456	78.23%	72.5%	0.5223	2,276	912.17	63.96%
75.0%	0.7109	1069.68	2,520	80.28%	75.0%	0.5790	2,354	964.54	67.63%
77.5%	0.7638	1105.33	2,588	82.43%	77.5%	0.6425	2,433	1018.24	71.39%
80.0%	0.8226	1140.99	2,654	84.56%	80.0%	0.7042	2,511	1064.96	74.67%
82.5%	0.8896	1176.65	2,710	86.34%	82.5%	0.7656	2,590	1106.43	77.58%
85.0%	0.9654	1212.30	2,773	88.35%	85.0%	0.8393	2,668	1149.84	80.62%
87.5%	1.0537	1247.96	2,824	89.97%	87.5%	0.9335	2,747	1197.38	83.95%
90.0%	1.1576	1283.61	2,879	91.70%	90.0%	1.0551	2,825	1248.50	87.54%
92.5%	1.2875	1319.27	2,940	93.66%	92.5%	1.2085	2,904	1298.86	91.07%
95.0%	1.4669	1354.93	3,005	95.72%	95.0%	1.3956	2,982	1342.26	94.11%
97.5%	1.7639	1390.58	3,070	97.80%	97.5%	1.7145	3,061	1386.27	97.20%
100.0%	3.6468	1426.24	3,139	100.00%	100.0%	3.6468	3,139	1426.24	100.00%

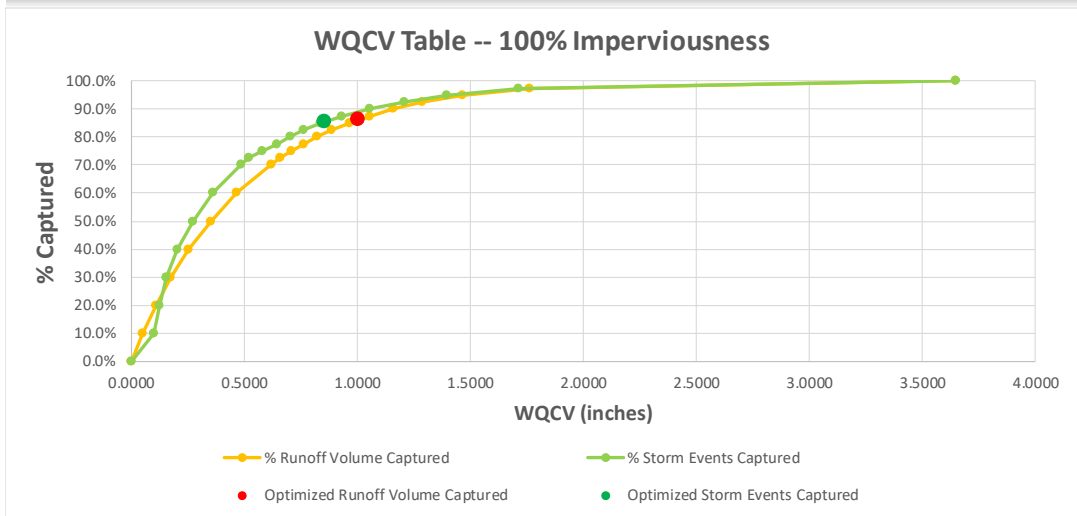

Figure 27. Optimal WQCV Basin Size using WQ-COSM for the FORT WORTH WSFO TX US (COOP:413285).

WQCV Table -- 100% Imperviousness									
Optimized Values:									
WQCV Based on Runoff Volume Captured					WQCV Based on Storm Events Captured				
Percent of Volume Captured (%)	WQCV (in)	Volume Captured (in)	Number of Storms Captured	Percent of Storms Captured (%)	Percent of Storms Captured (%)	WQCV (in)	Number of Storms Captured	Volume Captured (%)	Percent of Volume Captured (%)
85.8%	1.1004	1156.85	1,944	87.29%	87.3%	1.1004	1,944	1156.85	85.83%
Incremental WQCV Values:									
WQCV Based on Runoff Volume Captured					WQCV Based on Storm Events Captured				
Percent of Volume Captured (%)	WQCV (in)	Volume Captured (in)	Number of Storms Captured	Percent of Storms Captured (%)	Percent of Storms Captured (%)	WQCV (in)	Number of Storms Captured	Volume Captured (%)	Percent of Volume Captured (%)
0.0%	0.0000	0.00	0	0.00%	0.0%	0.0000	0	0.00	0.00%
10.0%	0.0604	134.78	69	3.09%	10.0%	0.1079	223	233.77	17.34%
20.0%	0.1261	269.56	312	14.02%	20.0%	0.1531	445	322.71	23.94%
30.0%	0.2000	404.33	631	28.35%	30.0%	0.2099	668	421.00	31.24%
40.0%	0.2862	539.11	905	40.63%	40.0%	0.2808	891	531.33	39.42%
50.0%	0.3877	673.89	1,134	50.90%	50.0%	0.3779	1,114	661.44	49.08%
60.0%	0.5131	808.67	1,389	62.39%	60.0%	0.4802	1,336	777.01	57.65%
70.0%	0.6757	943.45	1,603	71.96%	70.0%	0.6410	1,559	918.00	68.11%
72.5%	0.7238	977.14	1,663	74.66%	72.5%	0.6853	1,615	950.16	70.50%
75.0%	0.7781	1010.84	1,718	77.15%	75.0%	0.7298	1,670	981.37	72.81%
77.5%	0.8369	1044.53	1,772	79.59%	77.5%	0.7862	1,726	1015.72	75.36%
80.0%	0.9025	1078.23	1,827	82.05%	80.0%	0.8477	1,782	1050.16	77.92%
82.5%	0.9786	1111.92	1,881	84.47%	82.5%	0.9167	1,837	1084.50	80.47%
85.0%	1.0673	1145.62	1,929	86.60%	85.0%	1.0003	1,893	1120.24	83.12%
87.5%	1.1706	1179.31	1,976	88.73%	87.5%	1.1103	1,949	1160.21	86.08%
90.0%	1.2973	1213.00	2,035	91.37%	90.0%	1.2338	2,004	1197.37	88.84%
92.5%	1.4669	1246.70	2,084	93.57%	92.5%	1.3731	2,060	1229.23	91.20%
95.0%	1.6977	1280.39	2,125	95.41%	95.0%	1.6406	2,116	1273.21	94.47%
97.5%	2.0734	1314.09	2,170	97.43%	97.5%	2.1056	2,171	1316.34	97.67%
100.0%	3.9941	1347.78	2,227	100.00%	100.0%	3.9941	2,227	1347.78	100.00%

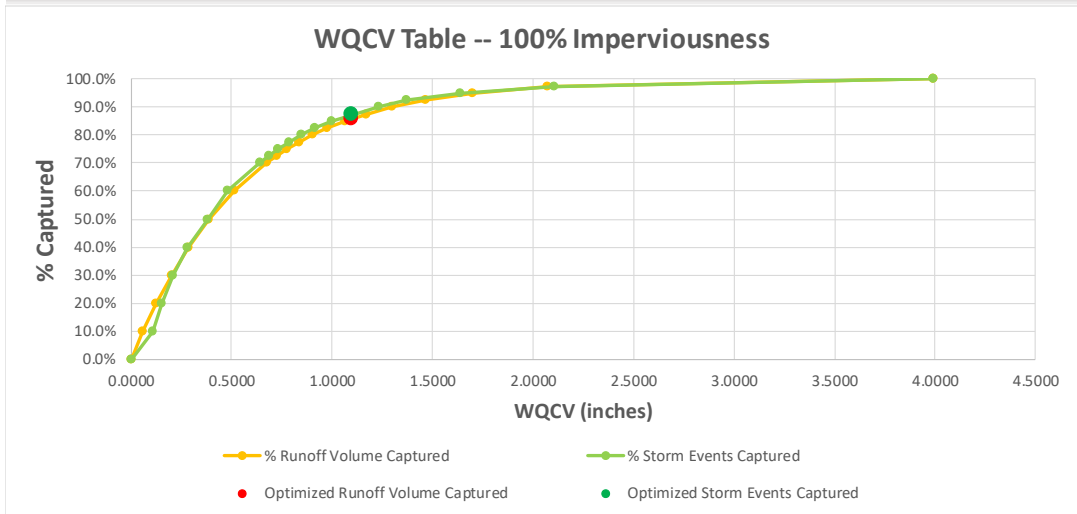

Figure 28. Optimal WQCV Basin Size using WQ-COSM for the FRISCO TX US (COOP:413370).



WQCV Table -- 100% Imperviousness									
Optimized Values:									
WQCV Based on Runoff Volume Captured					WQCV Based on Storm Events Captured				
Percent of Volume Captured (%)	WQCV (in)	Volume Captured (in)	Number of Storms Captured	Percent of Storms Captured (%)	Percent of Storms Captured (%)	WQCV (in)	Number of Storms Captured	Volume Captured (%)	Percent of Volume Captured (%)
85.7%	0.9923	1384.54	2,979	88.28%	86.7%	0.9129	2,924	1344.59	83.18%
Incremental WQCV Values:									
WQCV Based on Runoff Volume Captured					WQCV Based on Storm Events Captured				
Percent of Volume Captured (%)	WQCV (in)	Volume Captured (in)	Number of Storms Captured	Percent of Storms Captured (%)	Percent of Storms Captured (%)	WQCV (in)	Number of Storms Captured	Volume Captured (%)	Percent of Volume Captured (%)
0.0%	0.0000	0.00	0	0.00%	0.0%	0.0000	0	0.00	0.00%
10.0%	0.0523	161.65	29	0.86%	10.0%	0.1049	337	310.18	19.19%
20.0%	0.1100	323.29	397	11.75%	20.0%	0.1342	675	384.94	23.81%
30.0%	0.1764	484.94	1,063	31.51%	30.0%	0.1680	1,012	466.95	28.89%
40.0%	0.2552	646.59	1,505	44.60%	40.0%	0.2241	1,350	586.05	36.25%
50.0%	0.3494	808.24	1,881	55.75%	50.0%	0.2990	1,687	725.50	44.88%
60.0%	0.4638	969.88	2,244	66.50%	60.0%	0.3886	2,024	868.88	53.75%
70.0%	0.6132	1131.53	2,561	75.90%	70.0%	0.5120	2,362	1026.74	63.52%
72.5%	0.6584	1171.94	2,630	77.95%	72.5%	0.5484	2,446	1067.90	66.06%
75.0%	0.7073	1212.35	2,697	79.94%	75.0%	0.5954	2,531	1114.39	68.94%
77.5%	0.7630	1252.77	2,769	82.06%	77.5%	0.6474	2,615	1162.80	71.93%
80.0%	0.8240	1293.18	2,840	84.18%	80.0%	0.7088	2,699	1213.56	75.07%
82.5%	0.8923	1333.59	2,908	86.19%	82.5%	0.7746	2,784	1261.04	78.01%
85.0%	0.9700	1374.00	2,965	87.89%	85.0%	0.8498	2,868	1309.01	80.98%
87.5%	1.0591	1414.41	3,024	89.64%	87.5%	0.9491	2,952	1363.92	84.38%
90.0%	1.1661	1454.82	3,105	92.03%	90.0%	1.0736	3,037	1420.40	87.87%
92.5%	1.3079	1495.24	3,174	94.07%	92.5%	1.1892	3,121	1462.81	90.49%
95.0%	1.5025	1535.65	3,234	95.86%	95.0%	1.3981	3,205	1515.64	93.76%
97.5%	1.8067	1576.06	3,296	97.68%	97.5%	1.7729	3,290	1572.68	97.29%
100.0%	3.7311	1616.47	3,374	100.00%	100.0%	3.7311	3,374	1616.47	100.00%

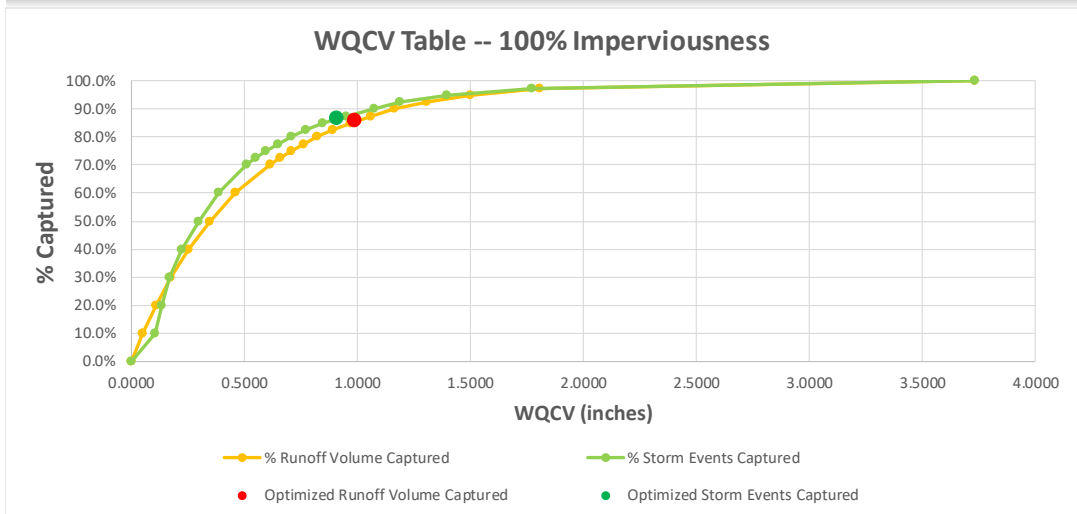

Figure 29. Optimal WQCV Basin Size using WQ-COSM for the GRAPEVINE DAM TX US (COOP:413691).

WQCV Table -- 100% Imperviousness									
Optimized Values:									
WQCV Based on Runoff Volume Captured					WQCV Based on Storm Events Captured				
Percent of Volume Captured (%)	WQCV (in)	Volume Captured (in)	Number of Storms Captured	Percent of Storms Captured (%)	Percent of Storms Captured (%)	WQCV (in)	Number of Storms Captured	Volume Captured (%)	Percent of Volume Captured (%)
86.2%	1.0676	1335.56	2,991	90.42%	86.7%	0.8968	2,867	1259.82	81.34%
Incremental WQCV Values:									
WQCV Based on Runoff Volume Captured					WQCV Based on Storm Events Captured				
Percent of Volume Captured (%)	WQCV (in)	Volume Captured (in)	Number of Storms Captured	Percent of Storms Captured (%)	Percent of Storms Captured (%)	WQCV (in)	Number of Storms Captured	Volume Captured (%)	Percent of Volume Captured (%)
0.0%	0.0000	0.00	0	0.00%	0.0%	0.0000	0	0.00	0.00%
10.0%	0.0524	154.89	26	0.78%	10.0%	0.1076	331	303.84	19.62%
20.0%	0.1102	309.78	364	11.01%	20.0%	0.1331	662	362.89	23.43%
30.0%	0.1783	464.67	1,191	35.99%	30.0%	0.1585	992	421.93	27.24%
40.0%	0.2600	619.55	1,608	48.59%	40.0%	0.2039	1,323	513.60	33.16%
50.0%	0.3599	774.44	1,952	59.00%	50.0%	0.2730	1,654	640.26	41.34%
60.0%	0.4818	929.33	2,264	68.45%	60.0%	0.3716	1,985	790.24	51.02%
70.0%	0.6358	1084.22	2,546	76.97%	70.0%	0.5047	2,316	956.11	61.73%
72.5%	0.6812	1122.94	2,610	78.90%	72.5%	0.5473	2,398	1000.62	64.60%
75.0%	0.7350	1161.67	2,689	81.28%	75.0%	0.5915	2,481	1045.45	67.50%
77.5%	0.7928	1200.39	2,765	83.57%	77.5%	0.6482	2,564	1094.81	70.68%
80.0%	0.8572	1239.11	2,834	85.69%	80.0%	0.7061	2,646	1141.02	73.67%
82.5%	0.9313	1277.83	2,894	87.50%	82.5%	0.7626	2,729	1181.44	76.28%
85.0%	1.0184	1316.55	2,962	89.54%	85.0%	0.8357	2,812	1226.40	79.18%
87.5%	1.1214	1355.28	3,020	91.30%	87.5%	0.9315	2,895	1277.92	82.51%
90.0%	1.2480	1394.00	3,079	93.08%	90.0%	1.0431	2,977	1326.27	85.63%
92.5%	1.4103	1432.72	3,139	94.90%	92.5%	1.2045	3,060	1381.77	89.21%
95.0%	1.6412	1471.44	3,198	96.67%	95.0%	1.4189	3,143	1434.44	92.61%
97.5%	2.0269	1510.17	3,247	98.15%	97.5%	1.8395	3,225	1493.84	96.45%
100.0%	4.0143	1548.89	3,308	100.00%	100.0%	4.0143	3,308	1548.89	100.00%

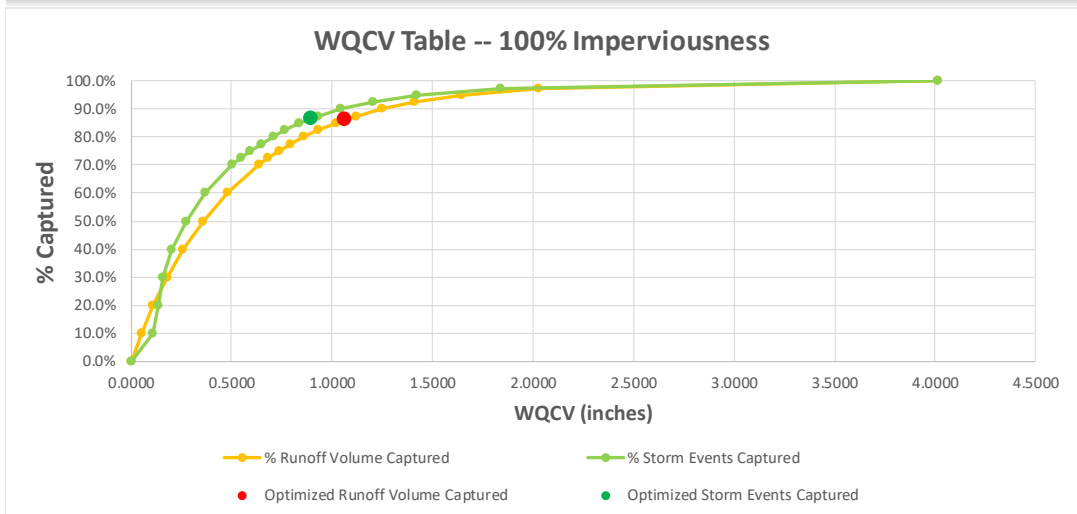

Figure 30. Optimal WQCV Basin Size using WQ-COSM for the JUSTIN TX US (COOP:414679).

## Appendix B

### Re-calculated 85<sup>th</sup>-percentile Storm Depth

The 85<sup>th</sup>-percentile 24-hour storm depths re-calculated for the NCDC stations shown in Figure 2 using continuous rainfall data are summarized in Table 2.

Table 2. 85<sup>th</sup>-percentile Storm Depth based on NCDC Continuous Rainfall Data.

Station	Station Name	Start Date	End Date	85th-pct Storm Depth (inches)
COOP:412404	DENTON 2 SE TX US	8/29/1946	12/21/2013	1.26
COOP:411921	COMMERCE 4 SW TX US	8/13/1948	12/21/2013	1.33
COOP:411246	BURLESON TX US	12/1/1982	12/21/2013	1.30
COOP:410691	BENBROOK DAM TX US	6/1/1949	12/21/2013	1.25
COOP:413370	FRISCO TX US	10/1/1966	12/21/2013	1.30
COOP:412096	CRESSON TX US	9/25/1946	12/21/2013	1.20
COOP:413284	FORT WORTH MEACHAM FIELD TX US	1/6/1940	12/29/2013	1.20
COOP:413285	FORT WORTH WSFO TX US	5/10/1948	1/1/2014	1.30
COOP:412242	DAL FTW WSCMO AIRPORT TX US	2/1/1974	12/29/2013	1.20
COOP:413133	FERRIS TX US	7/1/1946	12/20/2013	1.30
COOP:410518	BARDWELL DAM TX US	4/1/1965	12/21/2013	1.30
COOP:412244	DALLAS FAA AIRPORT TX US	11/4/1940	12/21/2013	1.30
COOP:410206	ALVORD 3 N TX US	4/8/1942	12/21/2013	1.23
COOP:415958	MINERAL WELLS AIRPORT TX US	3/18/1948	12/29/2013	1.20
COOP:415957	MINERAL WELLS 1 SSW TX US	3/1/1952	12/21/2013	1.30
COOP:415192	LEWISVILLE DAM TX US	7/1/1949	1/1/2014	1.28
COOP:415094	LAVON DAM TX US	7/1/1949	1/1/2014	1.30
COOP:413691	GRAPEVINE DAM TX US	6/1/1949	1/1/2014	1.30
COOP:416210	NAVARRO MILLS DAM TX US	8/1/1962	12/21/2013	1.30
COOP:418563	SPRINGTOWN 4 S TX US	11/1/1977	12/21/2013	1.30
COOP:415897	MIDLOTHIAN TX US	1/1/1974	12/21/2013	1.40
COOP:418623	STEPHENVILLE 9 NNE TX US	7/15/1940	12/21/2013	1.20
COOP:414972	LAKE BRIDGEPORT DAM TX US	8/1/1946	12/21/2013	1.20
COOP:415766	MCKINNEY MUNICIPAL AIRPORT TX US	4/1/1957	1/1/2014	1.97
COOP:414679	JUSTIN TX US	1/1/1954	12/21/2013	1.30
COOP:419532	WEATHERFORD TX US	10/1/1947	12/21/2013	1.20





# NCTCOG iSWM 5-Year Outreach and Implementation Strategy

Dated April 2021 **DRAFT**

Produced by:



## Table Of Contents

Introduction .....	2
Why iSWM.....	2
iSWM Overview .....	3
iSWM Certified Communities .....	4
Objectives & Goals .....	5
Challenges & Evaluation of Outcomes.....	5
Implementation Strategies .....	6
iSWM Promotion .....	7
Community Engagement.....	9
Technical Support and Training .....	12
Technical Content.....	15
References .....	19

## List of Appendicies

Appendix A: Implementation Strategies Matrix

Appendix B: Potential Interest Groups for Developer Outreach

## INTRODUCTION

This 5-Year Outreach and Implementation Strategy is a result of a collaboration between the North Central Texas Council of Governments (NCTCOG), consultants, and the iSWM Implementation Subcommittee with the intent to:

- Increase awareness of iSWM and iSWM principals.
- Identify key agencies, personnel and stakeholders (staff, leadership, elected officials) that need to be engaged through community outreach and with what level of frequency.
- Plan for continuous improvement to the program's technical content and training program.
- Refine the vision and messaging plan to be implemented over the next 5 years.

In order to achieve these goals, the implementation plan outlines specific tasks in the attempt to reach target audiences in multiple ways at different times to engage decision makers at cities in North Texas primarily through staff, elected and appointed officials, and the real estate development community.

### Why iSWM

The North Central Texas region has been experiencing rapid growth for decades and it continues at a record pace. This rapid growth throughout the region must be supported by a water supply that is completely reliant on the storage and treatment of stormwater runoff to drinking water standards. Challenges arise as development leads to the loss of more pervious and stormwater runoff limiting natural areas that are replaced by pavement and rooftops. This alteration of natural hydrology leads to more frequent flooding, exacerbated erosion in natural channels, and higher pollutant and sediment loadings flowing into our water supply reservoirs and riverine systems.

Legislative requirements related to stormwater management are constantly evolving at both the State and National levels. The iSWM program seeks to evolve with these changes and provide the tools and resources for North Texas counties and cities to be prepared for compliance with these changes now and into the future.

## State Requirements and Local Criteria

The iSWM program is a valuable resource for communities to help meet Texas Commission on Environmental Quality (TCEQ) requirements and also provides local guidance beyond compliance with legislative and funding requirements for stormwater management. It also helps communities plan for and implement local stormwater management ordinances and strategies that will serve to mitigate some of the many challenges associated with development and the consequential impacts on valuable natural systems and water resources in our region including:

- Localized and riverine flooding
- Streambank erosion
- Water quality concerns
- Loss of and damage to natural systems and ecosystems
- Regional consistency

The criteria and guidance manuals developed through the iSWM program and coupled with continuing outreach and education initiatives are geared to focus on helping communities effectively address and mitigate these impacts. Specific initiatives and community support programs provide the necessary tools to:

- Address stormwater early in the development process
- Design for multiple storm events
- Use integrated Site Design Practices
- Reduce downstream impacts
  - Water quality
  - Streambank erosion
  - Flooding
- Protect water quality during construction activities

## iSWM Overview

The core resources provided by the iSWM program include the following items that are continuously improved and updated to reflect current best practices in our region:

- Criteria Manual - Municipalities apply at local level
- Technical Manuals - Equations and methods for design
- Tools and Training - Archived training resources
- Program Guidance - Supplemental documents

The program supports and facilitates the utilization of these resources with a robust catalog of outreach and education materials that are developed and updated annually. Through collaboration with the regional iSWM committee, the outreach and educational needs along with updates to the criteria manual and technical manuals are prioritized and programmed on a year to year basis.



## iSWM Certified Communities

The iSWM program began in 2006. In 2014 the iSWM program moved to an outcome focused implementation process where communities become iSWM certified through the iSWM implementation process. Communities that participated in the program between 2006 and 2014 are considered Founding Members.

### iSWM Founding Member Timeline

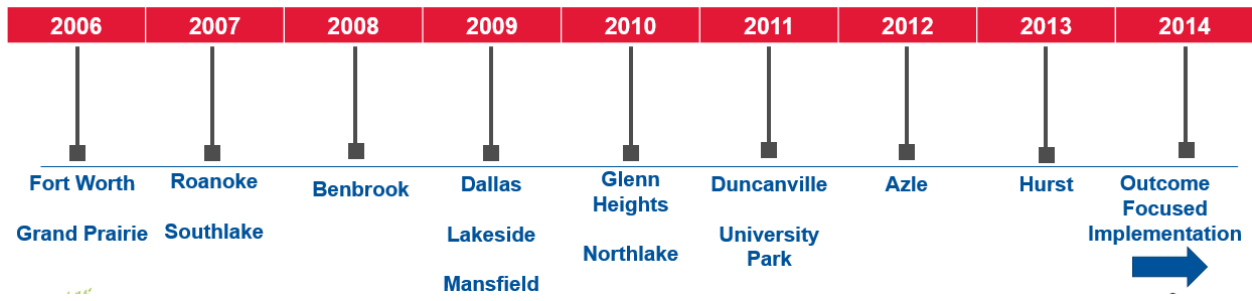

iSWM Certified Communities are communities that have documented and adopted iSWM practices. iSWM implementation is the process by which a community can become an iSWM Certified Community. iSWM Certified Communities criteria or ordinances have been reviewed and approved by the iSWM Implementation Subcommittee. In order to find out more about the implementation process please read the iSWM Implementation Review Process Guide (Reference 1).

Depending on the iSWM practices adopted in the community, the community receives bronze, silver, or gold certification status. Please review the iSWM Program Implementation Tiered Measurement (Reference 2) to find out more about the different levels of iSWM implementation.

### iSWM Silver Certified Communities



## Objectives & Goals

This strategic plan provides a roadmap to guide the selection, scheduling, and funding forecasting for future updates to the criteria and technical manuals, planning and promotion of training and outreach programs, and recommendations for the establishment of collaborative partnerships with a wide variety of community stakeholder groups and the development community. Key objectives and goals that are established with this plan include:

- Increase awareness of iSWM and iSWM principals.
- Refine the vision and messaging plan to be implemented over the next 5 years.
- Identify key levels (staff, leadership, elected officials) that need to be engaged and with what level of frequency.
- Influence decision makers at cities in North Texas primarily through staff, elected and appointed officials, and the real estate development community.
- Encourage participation and use of Site Development Controls manual and increase in water quality criteria standards throughout the region.

## Challenges & Evaluation of Outcomes

While it is important to set specific goals and strategies for a specific timeline, it is equally important to be cognizant of the challenges that exist that must be addressed to optimize the impact and effectiveness of the iSWM program. Regulation and development priorities within our region will always be changing. These changes will directly impact the community's inclination and motivation to modify and update development requirements particularly as they relate to management of stormwater. What will not change is that our region will continue to expand with new development and infill development albeit at fluctuating rates as dictated by economic conditions. As our area continues to grow the stressors on our natural resources, our water resources, and our recreational areas will expand. The complexity and expense required to mitigate these impacts will also expand as these stressors continue to accumulate. Some of the specific challenges that should be consistently evaluated and strategies to track progress include:

### Challenges

- Lack of regional consistency in requirements. Differing levels of implementation of stormwater strategies within shared watersheds leads to inequities between communities. (e.g. If upstream communities don't manage floatable debris, downstream communities are impacted)
- Retiring advocates of iSWM
- Constant turnover in leadership within communities requires constant advocacy for the program. It is imperative to communicate the value of the program in a common language. Emphasize the financial implications of the program as they relate to economic development, quality of life, and environmental and natural resources stability.

## Evaluation of outcomes

- Participation - # of iSWM communities, # of subcommittee participants
- Identification of community advocates and consistent collaboration and outreach.
- Evaluation of community participation based on spatial distribution within major sub-watersheds of the Trinity River, Elm Fork, East Fork and water supply reservoirs.
- Tracking of initiatives approved in ongoing and completed watershed management programs.
- Tracking of not only GSI implementation sites but quantification of water quality volume treated versus untreated.
- Development of an annual Trinity River Watershed 'Report Card' that highlights successes and areas in need of improvement.

## IMPLEMENTATION STRATEGIES

The implementation strategies of the iSWM 5-year strategy are specific tasks intended to be executed by the iSWM Implementation Subcommittee. These tasks are intended to meet the objectives and goals mentioned in the previous sections. As these tasks are implemented it will be important to ensure they overcome the challenges and meet the intended outcomes outlined previously. The implementation strategies are broken up into four key categories:

- iSWM Promotion
- Community Engagement
- Technical Support and Training
- Technical Content

An overview of each category and their potential tasks are discussed in the following sections. A title, description, and recommended implementation timeline are provided for each task. These tasks are prioritized based on their recommended implementation timelines. Implementation timelines for each task are either noted as:

- Short Term (Next 1-3 years)
- Mid-Term (Next 3-5 years)
- Long Term (Beyond 5-years)

The Implementation Strategies Matrix found in Appendix A is a summary table of implementation strategies. This matrix also includes a summary of the implementation plans, frequency of need for each task, potential implementation team, and an indication of level of effort (labor and budget) that would be required. Each task could be implemented by the subcommittee volunteers, NCTCOG staff, or a consultant team. In Appendix A, the level of effort indicator uses a range of one to three dollar signs (\$). One dollar sign indicates the task would require the least amount of labor and budget when compared to the other implementation strategies. Two dollar signs indicates a medium amount of effort and three dollar signs indicate the most level of effort. The estimations of level of efforts are based on the scope of each implementation strategy that is described in this strategy document. Since these implementation strategies are conceptual the scope of each individual task is subject to change either expanding or reducing the level of effort required for each task.

The purpose of the tasks within this category is to enhance iSWM marketing content to be used during community engagement to explain the environmental, economic, and community benefits of implementing and utilizing iSWM. These tools include case studies, videos, website enhancements, and visuals so that all members of the community can understand importance and purpose of the iSWM program.

---

### 1 Case Studies

Enhance the current archive of iSWM case studies with focus on the iSWM program from the perspective of an iSWM Certified Community or construction project utilizing iSWM standards. Case studies should be documented using preferably a video format.

#### **Focus on Communities:**

- Add iSWM case studies documenting communities' experience with the iSWM program.
- Case studies should identify features related to iSWM certification. Potential topics are:
  - Lessons learned or success stories in regards to streambank protection, flooding protection, or water quality
  - iSWM implementation into the Community's design criteria or ordinances
  - Staff expectations during the design and construction of projects utilizing iSWM criteria

#### **Focus on Projects:**

- Develop best practice videos of recent projects utilizing iSWM criteria.
  - Promote developer-submitted best practices videos of recent projects. Though case study projects could be documented and presented from the private or public perspective.
  - Encourage 2 minute maximum video with recommended highlights:
    - project stats and location
    - significant iSWM implementation strategies
    - implementation impact metrics
    - data on project's increased value, other benefits
    - lessons learned, best practices
  - Submission should include 30 second snippet for social media plugs.
  - Upload full-length version to iSWM website Case Studies page along with any additional information
  - Post short snippet to a relevant NCTCOG social media account & tag the developer, project, or city. Send links to city and whoever submitted to repost and build promotion.
-

	<ul style="list-style-type: none"> <li>• Send snippet and link to full-length video on iSWM website to news sources as a press release, including a few sentences about the significance of this particular project, framing a compelling news story.</li> <li>• <b>Implementation Plan:</b> Short Term (next 1-3 years) new case studies to be solicited biannually</li> </ul>
2	<p><b>Website Updates</b></p> <ul style="list-style-type: none"> <li>• Add images and visual cues to help people navigate website certification guidance page.</li> <li>• Clusters of images with callout text allow visual cues to hook the target user with a large number of resources in a small space</li> <li>• Utilize the long scroll layout to offer increasing depth of content as users scroll</li> <li>• Audience: General Public, Students, Community Partner Organizations <ul style="list-style-type: none"> <li>◦ Embed, link, and include existing resources and organizations for individuals to become more educated or involved in general stormwater management or iSWM. For example see Reference 3.</li> <li>◦ Include calls to action such as template letter to city leader about adopting iSWM</li> </ul> </li> <li>• Audience: City Staff <ul style="list-style-type: none"> <li>◦ Downloadable handouts, FAQ pages, or resources to share with city leaders (potentially the same resources offered at engagements)</li> <li>◦ Quick links to most frequently accessed documents or pages (by assessing website usage data)</li> <li>◦ Template slideshow to present iSWM to fellow staff and city leaders</li> </ul> </li> <li>• Audience: Private development community <ul style="list-style-type: none"> <li>◦ Links to iSWM policy &amp; guidance resources for each iSWM municipality</li> <li>◦ Quick links to best practices, case studies</li> <li>◦ Simple submission request for assistance finding qualified engineering &amp; design professionals in the NCTCOG region.</li> </ul> </li> <li>• <b>Implementation Plan:</b> To be implemented in the short term (next 1-3 years) as a single occurrence in the next 5-years.</li> </ul>
3	<p><b>Economic Benefits of iSWM</b></p> <ul style="list-style-type: none"> <li>• A basic summary of existing data and analysis on economic benefits of projects and techniques related to iSWM implementation to demonstrate value potential for public sector and private sector.</li> <li>• Highlight a few specific examples of economic benefits to municipalities and economic benefits to developers and property owners</li> <li>• Focus on Triple Bottom line metrics that include the total costs of financial, social, and environmental performance.</li> <li>• Focus on impacts of meeting specific metrics and specific infrastructure designs, such as streambank protection and the savings in hard armoring in the future.</li> <li>• May include real estate value of recreational greenspace as stormwater management infrastructure.</li> </ul>

	<ul style="list-style-type: none"> <li>• <b>Implementation Plan:</b> To be implemented in the mid-term (next 3-5 years) as a single occurrence in the next 5-years.</li> </ul>
--	--

## Community Engagement

The purpose of the tasks within this category is to gain awareness, energy, and involvement in the iSWM program throughout the NCTCOG region. Through this engagement, the intent and purpose of the iSWM program should be understood by not only designers, city staff, and contractors, but by the general public, elected officials, real estate and development community, etc. The ultimate intent of these tasks is increase participation of communities within the North Texas Region.

4	<p><b>Developer Outreach</b></p> <ul style="list-style-type: none"> <li>• Partner with industry and interest groups to present at events to promote iSWM and share best practices and successful projects</li> <li>• These events or presentations can be tailored to each organization’s membership objective or multiple organizations together.</li> <li>• Highlight the Redevelopment Guidance document (Reference 4)</li> <li>• Highlight Best Practices and newest Case Study projects in the NCTCOG region. Many of these groups enjoy promoting new development projects to keep their membership informed on the latest trends. Topics may be tailored further to most interesting topics, well-known developers, or specific cities.</li> <li>• See list of potential groups to partner with in Appendix B.</li> <li>• From these events the hope is more developers and people from the Real Estate community learn about iSWM and get involved in the IIS.</li> <li>• More in-depth questions and topics should be gathered for future NCTCOG trainings for developers, builders, etc. See Task 12.</li> <li>• <b>Implementation Plan:</b> To be implemented in the short term (next 1-3 years) annually over the next 5-years.</li> </ul>
5	<p><b>City Council Outreach &amp; Training</b></p> <ul style="list-style-type: none"> <li>• Identify Communities for outreach and training. <ul style="list-style-type: none"> <li>○ Targeted outreach and education for council members and communities within watershed management planning areas with at-risk and impacted waterbodies.</li> <li>○ Identify stakeholder municipalities along sensitive corridors or areas with specific issues that iSWM could impact such as Downstream Assessment, MS4 requirements, or water quality issues.</li> <li>○ Identify council members with water quality issues in their districts</li> <li>○ Identify bodies of water or streams that do not meet or barely meet state requirements.</li> </ul> </li> </ul>

- Identify overtaxed stormwater pipes and areas to concentrate drainage retrofits to support flood mitigation
- Reach out on multiple related issues separately, throughout the year to maximize number of times elected representative hears about iSWM benefits in their district. Target multiple officials within a single city.
- Volunteers from IIS could present about iSWM at city council meetings
- Expand Benefits and Incentives list (Reference 5) into a graphic flier and include benefits such as an impact on stormwater systems, water bodies, and long-term consequences.
- Consultant could develop resources for presentations to city councils that could be presented or shared by iSWM implementation subcommittee members, NCTCOG staff, consultant, or other volunteers.
  
- **Training:**
  - Develop training session for City Council retreats in non-participant or participating cities.
  - "Does your city want cleaner water? Worried about flooding and erosion? Your best line of defense is iSWM."
  - Develop 30 min workshop
  - Request retreat scheduler contact from city secretary
  - Develop relationships with individual elected officials who can lobby for this short addition to council retreat.
  - Assist staff in participating cities to prepare a brief overview of iSWM for council retreats to continue promotion of iSWM program.
  - Promotion of iSWM through city council work sessions or strategic planning
- **Implementation Plan:** To be implemented in the midterm (next 3-5 years) biannually over the next 5-years.

6	<h3>Non-profit Outreach Plan</h3> <ul style="list-style-type: none"> <li>• Develop outreach plan for regional non-profit groups education, implementation, and PPP opportunities discussion and identification.</li> <li>• Partner with private institutions interested in their environmental impact and also interested in being a leader in their field, to collaborate and coordinate ongoing, new construction, and redevelopment projects and resilience initiatives: Universities, Nonprofits, Hospitals, Museums and cultural institutions, etc.</li> <li>• Work with nonprofit groups seeking opportunities to give-back to the community and meaningful projects to participate in, whose mission aligns with healthy rivers and streams: <ul style="list-style-type: none"> <li>○ Master Naturalists</li> <li>○ Trinity Coalition and Trinity Paddle Trail group</li> <li>○ Trinity Park Conservancy (Dallas): internship program (in partnership with Groundwork Dallas) for high-school age students to work with underserved communities and incorporate education about river restoration.</li> <li>○ Groundwork Dallas</li> </ul> </li> </ul>
---	---

	<ul style="list-style-type: none"> <li>○ Fort Worth Rowing Club</li> <li>• iSWM manual and program can be a teaching tool and compendium document for these groups to see how their work compliments other regional stormwater initiatives.</li> <li>• Coordinate with Dallas CECAP (Comprehensive Environmental Climate Action Plan) other related municipal programs (with participating cities and non-participating cities) to work strategies in synergy with iSWM goals.</li> <li>• <b>Implementation Plan:</b> To be implemented in the midterm (next 3-5 years) biannually over the next 5-years.</li> </ul>
7	<p><b>Education Outreach Plan</b></p> <ul style="list-style-type: none"> <li>• Develop outreach plan for regional school districts for education and implementation.</li> <li>• Contact school districts in growing communities where new campuses will impact ecology.</li> <li>• Partner with local high school and college architecture and engineering programs to design a simple hands-on, STEM-based project promoting the benefits of iSWM. Example: Integrate drainage and flow calculations and hands-on water quality testing.</li> <li>• Preliminary List of local high school architecture and urban planning programs: CityLab HS (Dallas ISD), Molina HS (Dallas ISD), Richardson High School (Richardson ISD), Gilbreath Reed Career and Technical Center (Garland ISD), Career Center East (Lewisville ISD), Dubinski Career Center (Grand Prairie ISD), Rockwall CTE Center (Rockwall ISD), Mac Arthur HS (Irving ISD).</li> <li>• Preliminary List of NCTCOG region university architecture and urban planning degree programs: UTA - College of Architecture, Planning, and Public Affairs, SMU Lyles School of Engineering, UNT - Urban Policy and Planning.</li> <li>• <b>Implementation Plan:</b> To be implemented in the long term (beyond 5 years).</li> </ul>
8	<p><b>Stormwater Awards Program</b></p> <ul style="list-style-type: none"> <li>• Stormwater Awards Program with press releases and engaging project narrative.</li> <li>• Awards Program designed to give accolades to high achievers, create a reason for press about stormwater, and to promote a benchmark of success for others.</li> <li>• Could include a participating city, and one public and one private development project.</li> <li>• Present awards at an iSWM Subcommittee meeting (to promote this body which has a great impact on the program).</li> <li>• Consider live video documentation on a NCTCOG social media platform with a similar mission and large following.</li> <li>• Send a press release with images and a few sentences about the significance of these particular projects, framing a compelling news story.</li> <li>• <b>Implementation Plan:</b> To be implemented in the long term (beyond 5 years).</li> </ul>



9	<h3>Real Estate &amp; Developer Community Task Force</h3> <ul style="list-style-type: none"> <li>• Task Force could support the development of a guidance document for non-technical users about iSWM.</li> <li>• Additional subcommittee members would need to be added to support a subgroup, however the intention of this task is to give developers and other non-technical members a place in the iSWM program.</li> <li>• Develop Real Estate Community Task Force as a subgroup within the iSWM subcommittee to guide creation of iSWM Adoption Best Practices Handbook</li> <li>• Set up the Task Force: target prominent local developers in all industry sectors as well as regional developers familiar with constructing within iSWM regulations, who could be attracted to build in target iSWM member cities. <ul style="list-style-type: none"> <li>○ Gather a list from each member city of the projects and developers that have adhered to the iSWM regulations since iSWM adoption.</li> </ul> </li> <li>• Explain the Tiers as well as Guidance for Partial Application of Outcomes (Reference 6)</li> <li>• Explain the benefits to property owners &amp; developers: detail &amp; promote the long-term benefits that outweigh the upfront costs and relate to big-picture goals and long-term impacts.</li> <li>• Explain the benefits to the region: the impacts iSWM Certified cities have made, which policies they've adopted, and examples from their best compliant projects.</li> <li>• Develop list of potential incentives for developers, such as: <ul style="list-style-type: none"> <li>○ monetary (discount on stormwater utility fee, etc.)</li> <li>○ other (expedited permit applications, developable land waivers, etc.)</li> </ul> </li> <li>• Develop the specific ordinance language (Reference 7)</li> <li>• <b>Implementation Plan:</b> To be implemented in the long term (beyond 5 years).</li> </ul>
---	--

## Technical Support and Training

The purpose of the tasks within this category is to engage with communities interested in or involved with the iSWM program so they have the support, training, and assistance they need to understand and implement the iSWM program.

10	<h3>iSWM Implementation Training</h3> <ul style="list-style-type: none"> <li>• Hold workshops or trainings for communities interested in implementing iSWM</li> <li>• Review their current ordinances and regulations to see where they qualify for iSWM Credit. Identify opportunities to incorporate iSWM criteria into current ordinances.</li> <li>• <b>Implementation Plan:</b> To be implemented in the short term (next 1-3 years) annually over the next 5-years.</li> </ul>
----	--

11	<h3>BMP Design and Maintenance Training</h3> <ul style="list-style-type: none"> <li>• Continue training communities on engineering design or maintenance of BMPs</li> <li>• Gather recommended training topics from IIS members and communities.</li> <li>• Suggested Topics: <ul style="list-style-type: none"> <li>○ iSWM requirements for developers and the additional costs to comply</li> <li>○ Guidance for developers and engineer's on managing multiple projects with varying local criteria requirements across the communities in the NCTCOG region.</li> <li>○ Design of storm drain pipe systems using iSWM manual for engineers</li> </ul> </li> <li>• <b>Implementation Plan:</b> To be implemented in the short term (next 1-3 years) annually over the next 5-years.</li> </ul>
12	<h3>Developer Training</h3> <ul style="list-style-type: none"> <li>• As more developers, builders, etc. learn about iSWM educational webinars could be held geared towards this community. Developers see firsthand the many benefits to building to iSWM standards.</li> <li>• Potential topics: <ul style="list-style-type: none"> <li>○ Benefits of iSWM to different types of real estate development projects. How can developers participate?</li> <li>○ Examples of common iSWM applications (Redevelopment Guidance document)</li> <li>○ Case studies and locations for individual follow up visits (map)</li> <li>○ Participating cities and Non-participating cities in NCTCOG region. iSWM can be applied in any city, even without municipal participation</li> <li>○ Guest developers who have completed a recent project (especially if high-profile) would add an interesting expert perspective to the conversation. Questions for guest(s) could be used to convey key concepts of the iSWM program adding depth and value after a quick overview presentation of the program and their specific project</li> </ul> </li> <li>• As trainings are scheduled, they could be advertised with partner organizations such as The Real Estate Council (TREC), Urban Land Institute (ULI) Dallas-Fort Worth, and US Green Building Council (USGBC) North Texas.</li> <li>• <b>Implementation Plan:</b> To be implemented in the mid-term (next 3-5 years) or long term (beyond 5 years) annually over the next 5-years depending on need and involvement.</li> </ul>
13	<h3>Watershed Management Plan Community Outreach</h3> <ul style="list-style-type: none"> <li>• Outreach and education for communities within watershed management plan areas. Outreach could include: <ul style="list-style-type: none"> <li>○ Connect with staff and city leaders developing and administering plans</li> <li>○ Events could include NCTCOG staff-led activities</li> <li>○ Events could include pre-recorded webinars, videos, or handouts available on website for local staff to lead with NCTCOG staff present to answer questions.</li> </ul> </li> </ul>

	<ul style="list-style-type: none"> <li>○ Reach out on multiple related issues separately, throughout the year to maximize number of times individual hears about iSWM benefits in their community. Target multiple individuals within a single city.</li> <li>• <b>Implementation Plan:</b> To be implemented in the short term (next 1-3 years) biannually over the next 5-years.</li> </ul>
14	<p><b>iSWM Assistance Contact List</b></p> <ul style="list-style-type: none"> <li>• Develop a comprehensive list of engineer or city staff contacts for assistance working in any of the iSWM certified communities. Contacts should be able to share appropriate iSWM documents and guidance to developers.</li> <li>• This contact list can be a resource for developers or engineers assessing projects across the NCTCOG region. Could also be utilized by non-participating cities to enable quick comparable searches for local information when considering the options for iSWM adoption.</li> <li>• <b>Implementation Plan:</b> To be implemented in the short term (next 1-3 years) as a single occurrence over the next 5-years.</li> </ul>
15	<p><b>iSWM Designer Recognition Program</b></p> <ul style="list-style-type: none"> <li>• Develop an iSWM recognition program for engineers/planners/designers.</li> <li>• Certified individuals comprise a database of qualified professionals</li> <li>• Database list can be provided to participating cities for assistance to project applicants and to developers who are requesting assistance from NCTCOG</li> <li>• <b>Implementation Plan:</b> To be implemented in the long term (beyond 5 years).</li> </ul>

## Technical Content

The purpose of the tasks within this category is to enhance the technical materials of the iSWM program and make sure they remain current. These materials include the design criteria manual, technical manuals, and new materials as needed to allow communities to understand and implement the iSWM program.

Site Development Controls Technical Manual Updates	
16	<p>The following tasks are based on feedback received in a series of workshops held in October 2019 and February 2020. The goal of these workshops was to meet with technical members of the IIS to discuss modifications that could be made to the Technical Manual to ensure the document is easier to use.</p> <ul style="list-style-type: none"> <li>• Update remaining BMP summary pages in Site Development Controls manual. <ul style="list-style-type: none"> <li>○ The update should reduce the amount of detail on the current summary pages and be more readable/appealing.</li> </ul> </li> <li>• <b>Implementation Plan:</b> To be implemented in the short term (next 1-3 years) as a single occurrence in the next 5-years.</li> </ul>
17	<ul style="list-style-type: none"> <li>• Reorganization of Site Development Controls manual with categories. <ul style="list-style-type: none"> <li>○ Reduce the number of categories. The categories could be potentially broken up into categories such as: water quality, stream protection, and flood control.</li> </ul> </li> <li>• <b>Implementation Plan:</b> To be implemented in the short term (next 1-3 years) as a single occurrence in the next 5-years.</li> </ul>
18	<ul style="list-style-type: none"> <li>• Add a comprehensive acceptable vegetation list to Site Development Controls manual. <ul style="list-style-type: none"> <li>○ The Technical Manual needs a more simplified approach that helps make the decision for the engineer/designer.</li> <li>○ Potentially a small picture could be provided of each plant.</li> <li>○ It could be stated how many cycles it takes to establish and if it is dependent on native vs. non-native soils.</li> </ul> </li> <li>• <b>Implementation Plan:</b> To be implemented in the short term (next 1-3 years) as a single occurrence in the next 5-years.</li> </ul>
19	<ul style="list-style-type: none"> <li>• Addition of new specifications and design check lists to Site Development Controls manual.</li> <li>• <b>Implementation Plan:</b> To be implemented in the short term (next 1-3 years) as a single occurrence in the next 5-years.</li> </ul>
20	<ul style="list-style-type: none"> <li>• Add emerging BMPs into Site Development Controls manual.</li> <li>• <b>Implementation Plan:</b> To be implemented in the long term (beyond 5 years).</li> </ul>

21	<ul style="list-style-type: none"> <li>• Rework introduction of Site Development Controls manual. <ul style="list-style-type: none"> <li>○ The first pages of the manual could be replaced so the reader better understands the integrated design approach.</li> <li>○ Reduce the length of the introduction to 1-3 pages of high-level introduction and explanation and go into more details throughout the rest of the document and in appendices</li> <li>○ Clearly state in bold font that goal is 70% to 80% TSS removal (currently stated on page SD-8)</li> <li>○ Include specific statements in intro about compliance with MS4 requirements</li> <li>○ Move suitability (1.2) forward of description table (1.7)</li> <li>○ Design efficiencies table should be moved to the front</li> <li>○ Provide better guidance for situations where each device or category are most appropriate</li> </ul> </li> <li>• <b>Implementation Plan:</b> To be implemented in the long term (beyond 5 years).</li> </ul>
22	<p><b>Construction Controls Technical Manual Updates</b></p> <ul style="list-style-type: none"> <li>• Update Section 3.9 Sediment Basin design section based on feedback documented in Recommendations for Technical Feedback from iSWM Adopters memorandum to iSWM Implementation Subcommittee dated April 20, 2020 <ul style="list-style-type: none"> <li>○ Correct the wording to require a minimum dewatering time of 36 hours. To correct this in the Construction Controls technical manual, this will require a revision to the wording on page CC-135 Step 14 (a). The wording will be needed to change from a 6-hour drawdown time to 36 hours. Also, the 21,600 seconds representing 6 hours will need to be increased to 129,600 seconds representing 36 hours.</li> <li>○ Remove the reference to Section 3.8 of the criteria manual and replace with a reference to Section 1.0 or Table 1.1 in the Hydrologic Technical Manual to determine which hydrologic method is appropriate for their site.</li> <li>○ Add wording to Section 3.9.3 on page CC-118 that surface skimmers may be reusable. Also change the wording on the last bullet point of page CC-118 to "A perforated riser can be used as an outlet only when surface discharge is not feasible."</li> </ul> </li> <li>• <b>Implementation Plan:</b> To be implemented in the short term (next 1-3 years) as a single occurrence in the next 5-years.</li> </ul>
	<p><b>Hydrology and Hydraulics Technical Manual Updates</b></p> <p>Update technical manual based on feedback documented in Recommendations for Technical Feedback from iSWM Adopters memorandum to iSWM Implementation Subcommittee dated April 20, 2020.</p>

23	<ul style="list-style-type: none"> <li>• Correct error found in the frustrum of a pyramid formula in the Hydraulic Technical Manual.</li> <li>• Add guidance for calculations for an on-grade inlet for a parabolic crowned street.</li> <li>• Revise wording in Section 1.3.7 Simplified SCS Peak Runoff section to refer to TR 55 for full description.</li> <li>• <b>Implementation Plan:</b> To be implemented in the short term (next 1-3 years) as a single occurrence in the next 5-years.</li> </ul>
24	<ul style="list-style-type: none"> <li>• Reformat detention sizing sections in Hydrologic Technical Manual to be clearer and more concise.</li> <li>• <b>Implementation Plan:</b> To be implemented in the mid-term (next 3-5 years) as a single occurrence in the next 5-years.</li> </ul>
25	<p><b>Forebay Design Guidance</b></p> <ul style="list-style-type: none"> <li>• Provide recommendation for additional design guidance for forebays.</li> <li>• <b>Implementation Plan:</b> To be implemented in the short term (next 1-3 years) as a single occurrence in the next 5-years.</li> </ul>
26	<p><b>Hydrologic Mimicry Research</b></p> <ul style="list-style-type: none"> <li>• Research hydrologic mimicry cases studies and guidance on greenfield/greyfield development scenarios in surround communities. Provide recommendation for mimicry guidance and target goals for volume management. This could be complimentary or perhaps an alternative to 85th percentile storm event.</li> <li>• <b>Implementation Plan:</b> To be implemented in the short term (next 1-3 years) as a single occurrence in the next 5-years.</li> </ul>
27	<p><b>Pipe utility crossings BMP guidance.</b></p> <ul style="list-style-type: none"> <li>• Provide recommendations for pipe utility crossing design for BMPs.</li> <li>• <b>Implementation Plan:</b> To be implemented in the mid-term (next 3-5 years) as a single occurrence in the next 5-years.</li> </ul>
28	<p><b>iSWM Project Signage Recommendations</b></p> <ul style="list-style-type: none"> <li>• Develop recommendations for public signage when a project is constructed utilizing iSWM design criteria, including the availability of the iSWM logo in high-resolution.</li> <li>• <b>Implementation Plan:</b> To be implemented in the mid-term (next 3-5 years) as a single occurrence in the next 5-years.</li> </ul>
29	<p><b>MS4 Permit Design Guidance for LID/GSI</b></p> <ul style="list-style-type: none"> <li>• Develop guidance document regarding the use of Low Impact Development (LID) BMPs and Green Stormwater Infrastructure (GSI) to comply with MS4 permit requirements.</li> <li>• <b>Implementation Plan:</b> To be implemented in the long term (beyond 5 years).</li> </ul>

30	<b>Review of iSWM Design &amp; Criteria Manual</b> <ul style="list-style-type: none"><li>• Set up committee to review and rewrite Design Criteria manual.</li><li>• <b>Implementation Plan:</b> To be implemented in the long term (beyond 5 years).</li></ul>
31	<b>Design &amp; Criteria Manual Visual Companion</b> <ul style="list-style-type: none"><li>• Develop a visual companion to represent the application and implementation process. This could be a flow chart that explains the process and purpose of implementing the iSWM program for people of all positions and technical abilities. Include images that demonstrate project examples/case studies.</li><li>• <b>Implementation Plan:</b> To be implemented in the long term (beyond 5 years).</li></ul>

## REFERENCES

1. iSWM Implementation Review Process Guide  
[http://iswm.nctcog.org/Documents/iSWM\\_Implementation\\_Review\\_Process.pdf](http://iswm.nctcog.org/Documents/iSWM_Implementation_Review_Process.pdf)
2. iSWM Program Implementation Tiered Measurement  
[https://resources.nctcog.org/envir/SEEclean/wq/tmdl/iSWM\\_Implementation\\_Tiered\\_Measurement.pdf](https://resources.nctcog.org/envir/SEEclean/wq/tmdl/iSWM_Implementation_Tiered_Measurement.pdf)
3. Stormwater Management in North Central Texas  
[https://www.youtube.com/watch?v=1L\\_4suLO-wo](https://www.youtube.com/watch?v=1L_4suLO-wo)
4. Redevelopment Guidance document  
<http://iswm.nctcog.org/Documents/iSWM-Redevelopment-Guidance.pdf>
5. iSWM Benefits and Incentives  
[http://iswm.nctcog.org/Documents/iSWM\\_Benefits\\_and\\_Incentives.pdf](http://iswm.nctcog.org/Documents/iSWM_Benefits_and_Incentives.pdf)
6. iSWM Implementation Guidance for Partial Outcomes  
[http://iswm.nctcog.org/Documents/iSWM\\_Guidance\\_for\\_Partial\\_Application\\_of\\_Outcomes.pdf](http://iswm.nctcog.org/Documents/iSWM_Guidance_for_Partial_Application_of_Outcomes.pdf)
7. integrated Site Design Practices Sample Ordinance Language  
<http://iswm.nctcog.org/Documents/Sample-Ordinance-Language-for-Integrated-Site-Design-Practices.pdf>



APPENDIX A: IMPLEMENTATION STRATEGIES MATRIX

Task	Implementation Timeline			Frequency of Need	Implementation Team	Level of Effort *
	Short Term (Next 1-3 Years)	Mid-Term (Next 3-5 Years)	Long Term (Beyond 5 Years)			
<b>iSWM Promotion</b>						
1 Case Studies	<input checked="" type="checkbox"/>	<input checked="" type="checkbox"/>	<input checked="" type="checkbox"/>	Biannually	NCTCOG & Consultant Team	\$\$
2 Website Updates	<input checked="" type="checkbox"/>			Single Occurrence	NCTCOG & Consultant Team	\$\$
3 Economic Benefits of iSWM		<input checked="" type="checkbox"/>		Single Occurrence	Consultant Team	\$\$
<b>Community Engagement</b>						
4 Developer Outreach	<input checked="" type="checkbox"/>	<input checked="" type="checkbox"/>	<input checked="" type="checkbox"/>	Annually	NCTCOG & Consultant Team	\$
5 City Council Outreach & Training		<input checked="" type="checkbox"/>	<input checked="" type="checkbox"/>	Biannually	NCTCOG & Consultant Team	\$\$
6 Non-profit Outreach Plan		<input checked="" type="checkbox"/>		Biannually	NCTCOG & Consultant Team	\$\$
7 Education Outreach Plan			<input checked="" type="checkbox"/>	Single Occurrence	NCTCOG & Consultant Team	\$\$
8 Stormwater Awards Program			<input checked="" type="checkbox"/>	Single Occurrence	NCTCOG & Consultant Team	\$\$
9 Real Estate & Developer Community Task Force			<input checked="" type="checkbox"/>	Single Occurrence	NCTCOG, Subcommittee, Consultant Team	\$\$
<b>Technical Support and Training</b>						
10 iSWM Implementation Training	<input checked="" type="checkbox"/>	<input checked="" type="checkbox"/>	<input checked="" type="checkbox"/>	Annually	NCTCOG & Consultant Team	\$
11 BMP Design and Maintenance Training	<input checked="" type="checkbox"/>	<input checked="" type="checkbox"/>	<input checked="" type="checkbox"/>	Annually	NCTCOG & Consultant Team	\$
12 Developer Training		<input checked="" type="checkbox"/>	<input checked="" type="checkbox"/>	Annually	NCTCOG & Consultant Team	\$
13 Watershed Management Plan Community Outreach	<input checked="" type="checkbox"/>			Biannually	NCTCOG & Consultant Team	\$\$
14 iSWM Assistance Contact List	<input checked="" type="checkbox"/>			Single Occurrence	NCTCOG & Consultant Team	\$
15 iSWM Designer Recognition Program			<input checked="" type="checkbox"/>	Single Occurrence	NCTCOG & Consultant Team	\$\$
<b>Technical Content</b>						
16 Site Development Controls Technical Manual Updates Update remaining BMP summary pages in Site Development Controls manual.	<input checked="" type="checkbox"/>			Single Occurrence	NCTCOG, Subcommittee, Consultant Team	\$
17 Reorganization of Site Development Controls manual with categories.	<input checked="" type="checkbox"/>			Single Occurrence	NCTCOG, Subcommittee, Consultant Team	\$\$
18 Add a comprehensive acceptable vegetation list to Site Development Controls manual.	<input checked="" type="checkbox"/>			Single Occurrence	NCTCOG, Subcommittee, Consultant Team	\$\$
19 Addition of new specifications and design check lists to Site Development Controls manual.	<input checked="" type="checkbox"/>			Single Occurrence	NCTCOG, Subcommittee, Consultant Team	\$\$
20 Add emerging BMPs into Site Development Controls manual.			<input checked="" type="checkbox"/>	Single Occurrence	NCTCOG, Subcommittee, Consultant Team	\$\$\$
21 Rework introduction of Site Development Controls manual.			<input checked="" type="checkbox"/>	Single Occurrence	NCTCOG, Subcommittee, Consultant Team	\$\$\$
22 Construction controls Technical Manual Updates	<input checked="" type="checkbox"/>			Single Occurrence	NCTCOG, Subcommittee, Consultant Team	\$\$
23 Hydrology and hydraulic Technical Manual Updates Correct frustum of a pyramid formula, additional on-grade inlet guidance, and TR-55 rewording	<input checked="" type="checkbox"/>			Single Occurrence	NCTCOG, Subcommittee, Consultant Team	\$
24 Reformat detention sizing sections in Hydrologic Technical Manual		<input checked="" type="checkbox"/>		Single Occurrence	NCTCOG, Subcommittee, Consultant Team	\$\$
25 Forebay Design Guidance	<input checked="" type="checkbox"/>			Single Occurrence	NCTCOG, Subcommittee, Consultant Team	\$
26 Hydrologic Mimicry Research	<input checked="" type="checkbox"/>			Single Occurrence	NCTCOG, Subcommittee, Consultant Team	\$
27 Pipe Utility Crossing Design Guidance		<input checked="" type="checkbox"/>		Single Occurrence	NCTCOG, Subcommittee, Consultant Team	\$\$
28 iSWM Project Signage Recommendations		<input checked="" type="checkbox"/>		Single Occurrence	NCTCOG, Subcommittee, Consultant Team	\$\$
29 MS4 Permit Design Guidance for LID/GSI			<input checked="" type="checkbox"/>	Single Occurrence	NCTCOG, Subcommittee, Consultant Team	\$\$
30 Review of iSWM Design & Criteria Manual			<input checked="" type="checkbox"/>	Single Occurrence	NCTCOG, Subcommittee, Consultant Team	\$\$\$
31 Design & Criteria Manual Visual Companion			<input checked="" type="checkbox"/>	Single Occurrence	NCTCOG, Subcommittee, Consultant Team	\$\$\$
<p>* Level of effort indicator uses a range of one to three dollar signs (\$) to indicate the level of effort (labor and budget) when compared with other implementation strategies.  \$ = Implementation strategy would require the least amount of effort when compared to the other implementation strategies  \$\$ = Implementation strategy would require medium amount of effort when compared to the other implementation strategies  \$\$\$ = Implementation strategy would require the most level of effort when compared to the other implementation strategies  The estimates of level of efforts are based on the scope of each implementation strategy that is described in this strategy document. Since these implementation strategies are conceptual the scope of each individual task is subject to change either expanding or reducing the level of effort required for each task.</p>						

## APPENDIX B: POTENTIAL INTEREST GROUPS FOR DEVELOPER OUTREACH

- **Urban Land Institute (ULI):**  
Development professionals primarily including planners, designers and developers but also including banking and finance. Organization supports 30 Councils (specific national or local groups) for various product types (e.g. - University Development, Public Development & Infrastructure, Redevelopment & Reuse, etc.) Dallas-Fort Worth Chapter.
- **The Real Estate Council (TREC):**  
Local real estate professionals from a variety of industries especially including construction and finance. NCTCOG region only.
- **American Institute of Architects (AIA):**  
Architects and Interior Design professionals interested in best practices and lessons learned in design. Dallas Chapter.
- **American Planning Association (APA):**  
Urban planners primarily from the public sector interested in best practices for policy and project design. Texas Chapter, North Central Section.
- **American Society of Landscape Architects (ASLA):**  
landscape designers interested in best practices for project design. DFW Chapter.
- **US Green Building Council (USGBC):**  
Organization overseeing LEED Certification (Leadership in Energy Efficiency and Design) for projects and individual practitioners. Interested in eco-friendly design and best practices especially as related to LEED Certified (New Construction or Redevelopment Buildings, Site planning, and Neighborhood projects. North Texas Chapter.
- **Greater Dallas Planning Council (GDPC):**  
Membership of design professionals and civic leaders interested in staying abreast of regional and local planning initiatives and weighing in on local and regional planning projects. NCTCOG region only.
- **Congress for the New Urbanism (CNU):**  
Organization for individuals interested in promoting walkable urbanism from any industry or walk of life. Members range from real estate professionals including small developers pushing the envelope, to concerned citizens and activists. North Texas Chapter.
- **Dallas Builders Association (DBA):**  
Trade association representing all segments of the residential building industry in the Dallas Metropolitan area. Its mission is to enhance its members' ability to provide safe, affordable, quality housing to the citizens of the local communities. Dallas only.

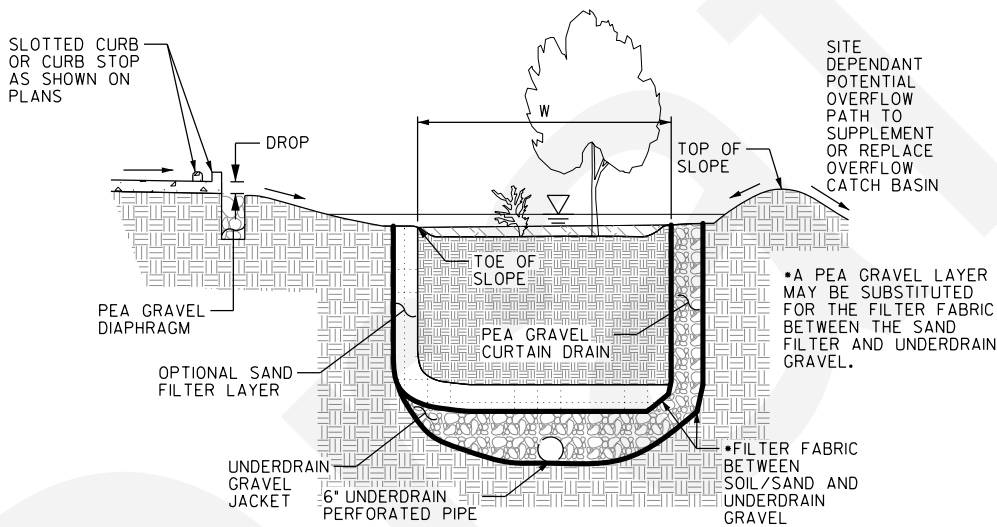
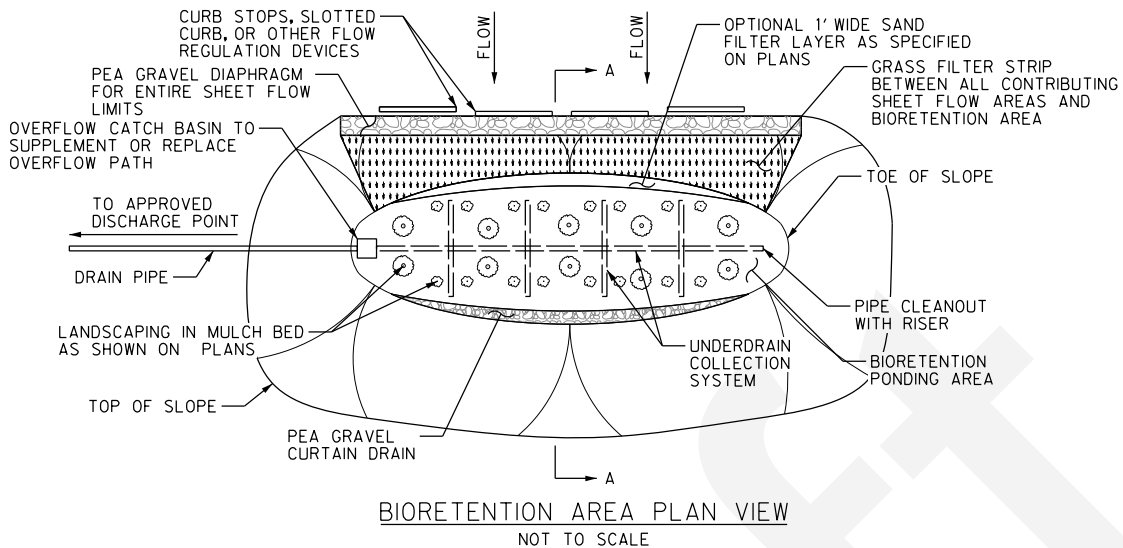

**NOTES:**

1. RECOMMENDED MINIMUM WIDTH AND LENGTHS ARE 10' AND 40', RESPECTIVELY BUT MAY VARY SO LONG AS A 2L:1W RATIO IS MAINTAINED. ACTUAL DIMENSIONS SHALL BE PROVIDED BY DESIGNER IN PLANS AND SHALL BE BASED ON SITE SPECIFIC CONDITIONS. DESIGN PROFESSIONAL SHALL AT A MINIMUM PROVIDE THE FOLLOWING INFORMATION:
  - HORIZONTAL CONTROL
  - VERTICAL CONTROL
  - LANDSCAPING
  - WATER QUALITY PROTECTION VOLUME
  - STREAMBANK PROTECTION VOLUME
  - FLOOD DISCHARGE
  - OVERFLOW (CATCH BASIN AND/OR PATH)
  - MEDIA SECTION AND RESPECTIVE THICKNESSES
  - DRAINAGE AGGREGATE AND UNDERDRAIN INFORMATION
2. DESIGN ENGINEER IS RESPONSIBLE FOR PROVIDING CALCULATIONS THAT DEMONSTRATE THAT COMPOSITE MEDIA AND SYSTEM AS A WHOLE CAN EFFECTIVELY TREAT THE WATER QUALITY VOLUME (WQV) AS SPECIFIED IN SECTION 1.4 OF THE NCTCOG WATER QUALITY TECHNICAL MANUAL. FLOW IN EXCESS OF THE WQV SHALL BE DESIGNED TO BYPASS THE SYSTEM VIA THE OVERFLOW SYSTEM(S).
3. DESIGN OF THIS SYSTEM SHALL FOLLOW THAT OF SECTION 2 "BIORETENTION AREA" CONTAINED IN THE NCTCOG SITE DEVELOPMENT CONTROLS ISWM TECHNICAL MANUAL.
4. LANDSCAPING SPECIFIED BY DESIGNER SHOULD BE CAREFULLY CHOSEN TO ENSURE SURVIVABILITY DURING BOTH SUBMERGED AND DROUGHT EXTREMES.
5. DESIGNER SHALL BE RESPONSIBLE FOR PREPARING AN OPERATIONS AND MAINTENANCE MANUAL OR MATRIX FOR SYSTEMS TO AID OWNER IN DETERMINING MAINTENANCE PROCEDURES AND INTERVALS. DESIGNER SHALL ALSO CONSIDER MAINTENANCE ACCESS WHEN DESIGNING SYSTEM.
6. DESIGNER SHALL ENSURE THAT SYSTEM IS CAPABLE OF BEING FULLY DRAINED WITHIN 48-HOURS.

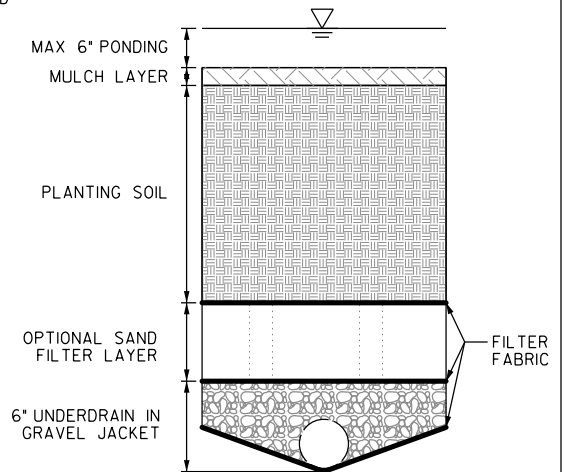

**MEDIA CUT SECTION**  
NOT TO SCALE

**FIGURE X.X**  
**SCHEMATIC OF A SHEET FLOW BIORETENTION AREA**

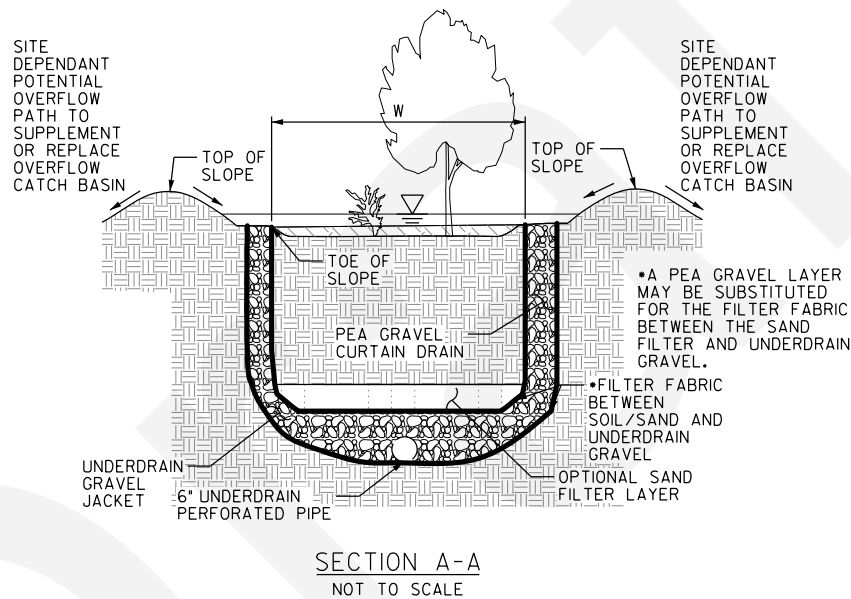
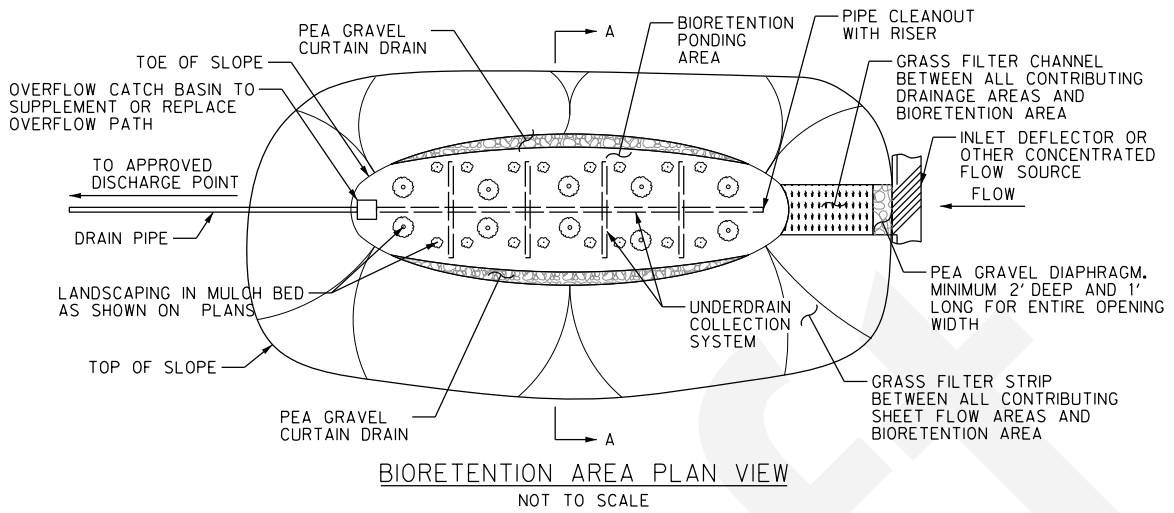

**NOTES:**

- RECOMMENDED MINIMUM WIDTH AND LENGTHS ARE 10' AND 40', RESPECTIVELY BUT MAY VARY SO LONG AS A 2L:1W RATIO IS MAINTAINED. ACTUAL DIMENSIONS SHALL BE PROVIDED BY DESIGNER IN PLANS AND SHALL BE BASED ON SITE SPECIFIC CONDITIONS. DESIGN PROFESSIONAL SHALL AT A MINIMUM PROVIDE THE FOLLOWING INFORMATION:
  - HORIZONTAL CONTROL
  - VERTICAL CONTROL
  - LANDSCAPING
  - WATER QUALITY PROTECTION VOLUME
  - STREAMBANK PROTECTION VOLUME
  - FLOOD DISCHARGE
  - OVERFLOW (CATCH BASIN AND/OR PATH)
  - MEDIA SECTION AND RESPECTIVE THICKNESSES
  - DRAINAGE AGGREGATE AND UNDERDRAIN INFORMATION
- DESIGN ENGINEER IS RESPONSIBLE FOR PROVIDING CALCULATIONS THAT DEMONSTRATE THAT COMPOSITE MEDIA AND SYSTEM AS A WHOLE CAN EFFECTIVELY TREAT THE WATER QUALITY VOLUME (WQV) AS SPECIFIED IN SECTION 1.4 OF THE NCTCOG WATER QUALITY TECHNICAL MANUAL. FLOW IN EXCESS OF THE WQV SHALL BE DESIGNED TO BYPASS THE SYSTEM VIA THE OVERFLOW SYSTEM(S).
- DESIGN OF THIS SYSTEM SHALL FOLLOW THAT OF SECTION 2 'BIORETENTION AREA' CONTAINED IN THE NCTCOG SITE DEVELOPMENT CONTROLS ISWM TECHNICAL MANUAL.
- LANDSCAPING SPECIFIED BY DESIGNER SHOULD BE CAREFULLY CHOSEN TO ENSURE SURVIVABILITY DURING BOTH SUBMERGED AND DROUGHT EXTREMES.
- DESIGNER SHALL BE RESPONSIBLE FOR PREPARING AN OPERATIONS AND MAINTENANCE MANUAL OR MATRIX FOR SYSTEMS TO AID OWNER IN DETERMINING MAINTENANCE PROCEDURES AND INTERVALS. DESIGNER SHALL ALSO CONSIDER MAINTENANCE ACCESS WHEN DESIGNING SYSTEM.
- DESIGNER SHALL ENSURE THAT SYSTEM IS CAPABLE OF BEING FULLY DRAINED WITHIN 48-HOURS.

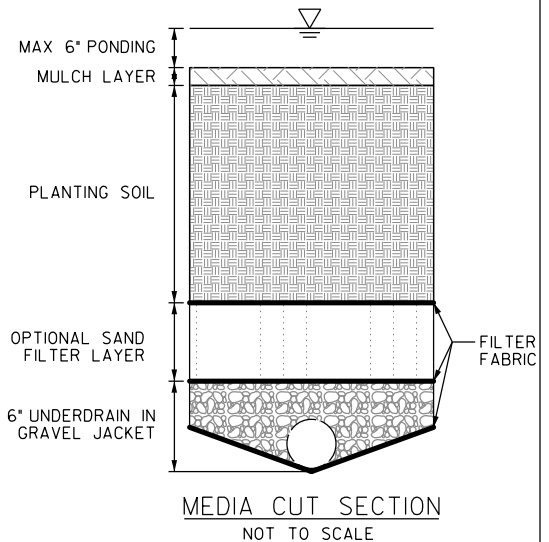

**FIGURE X.X**  
**SCHEMATIC OF A CONCENTRATED FLOW BIORETENTION AREA**

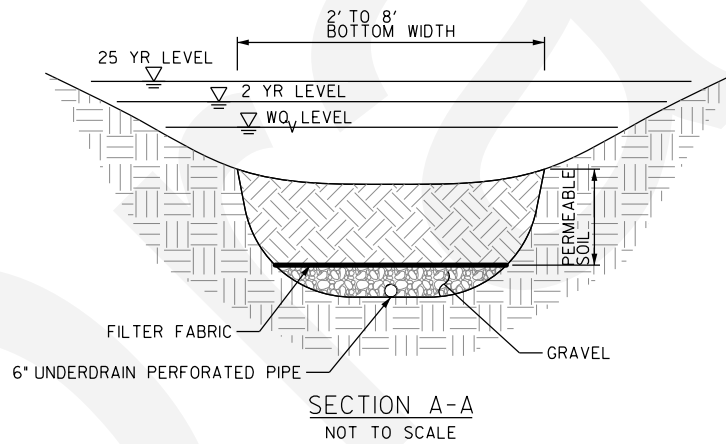
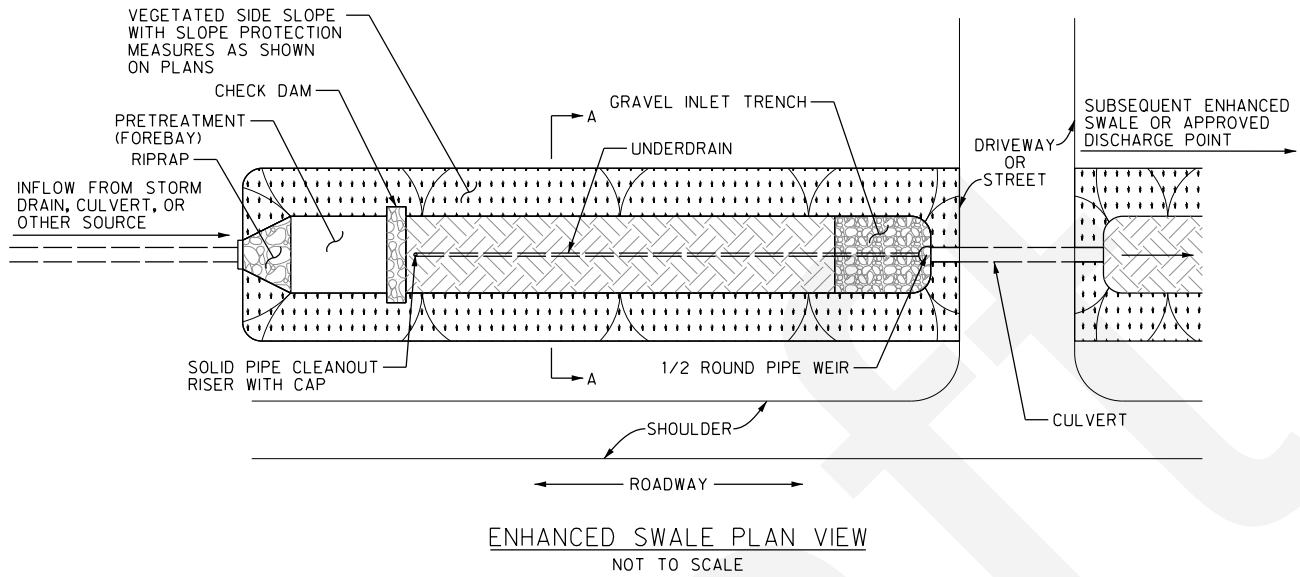

**NOTES:**

1. RECOMMENDED WIDTHS OF ENHANCED SWALES IS BETWEEN 2 AND 8 FEET. DIMENSIONS SHALL BE PROVIDED BY DESIGNER IN PLANS AND SHALL BE BASED ON SITE SPECIFIC CONDITIONS. DESIGN PROFESSIONAL SHALL AT A MINIMUM PROVIDE THE FOLLOWING INFORMATION:
  - HORIZONTAL CONTROL
  - VERTICAL CONTROL
  - WATER QUALITY PROTECTION VOLUME
  - STREAMBANK PROTECTION VOLUME
  - FLOOD DISCHARGE
  - PRETREATMENT INFORMATION
  - PERMEABLE SOIL CHARACTERISTICS
  - OVERFLOW PATH FOR 25-YR + EVENTS
  - ROCK RIP RAP GRADATION
  - CULVERT OR WEIR CALCULATIONS
  - DRAINAGE AGGREGATE AND UNDERDRAIN INFORMATION
2. DESIGN ENGINEER IS RESPONSIBLE FOR PROVIDING CALCULATIONS THAT DEMONSTRATE THAT PERMEABLE MEDIA AND SYSTEM AS A WHOLE CAN EFFECTIVELY TREAT THE WATER QUALITY VOLUME (WQv) AS SPECIFIED IN SECTION 1.4 OF THE NCTCOG WATER QUALITY TECHNICAL MANUAL. FLOW IN EXCESS OF THE WQv SHALL BE DESIGNED TO BYPASS THE SYSTEM VIA THE OVERFLOW SYSTEM(S).
3. DESIGN OF THIS SYSTEM SHALL FOLLOW THAT OF SECTION 3 'ENHANCED SWALE' CONTAINED IN THE NCTCOG SITE DEVELOPMENT CONTROLS ISWM TECHNICAL MANUAL.
4. DESIGNER SHALL BE RESPONSIBLE FOR PREPARING AN OPERATIONS AND MAINTENANCE MANUAL OR MATRIX FOR SYSTEMS TO AID OWNER IN DETERMINING MAINTENANCE PROCEDURES AND INTERVALS. DESIGNER SHALL ALSO CONSIDER MAINTENANCE ACCESS WHEN DESIGNING SYSTEM.

**FIGURE X.X**  
**SCHEMATIC OF AN ENHANCED DRY SWALE**

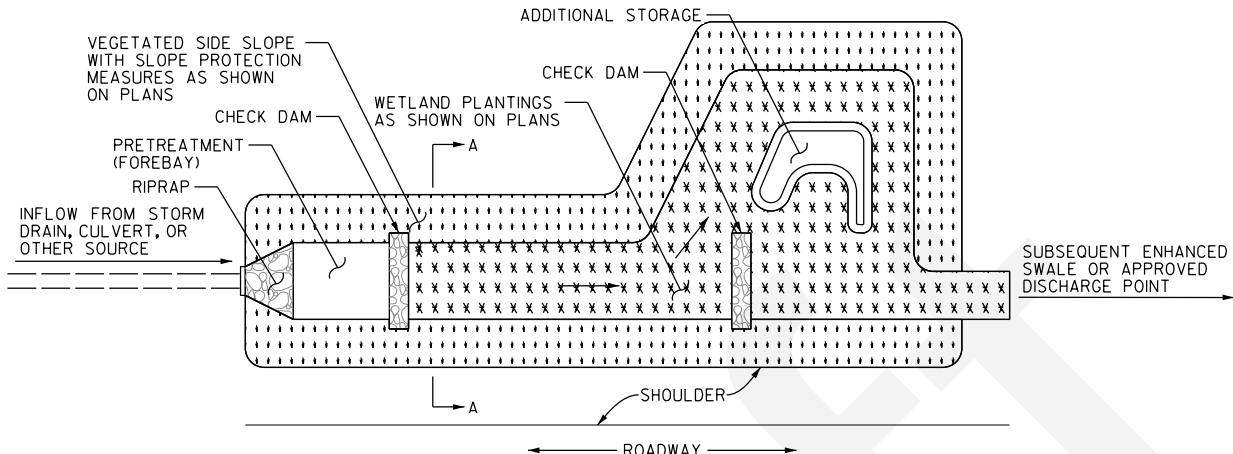

ENHANCED SWALE PLAN VIEW  
NOT TO SCALE

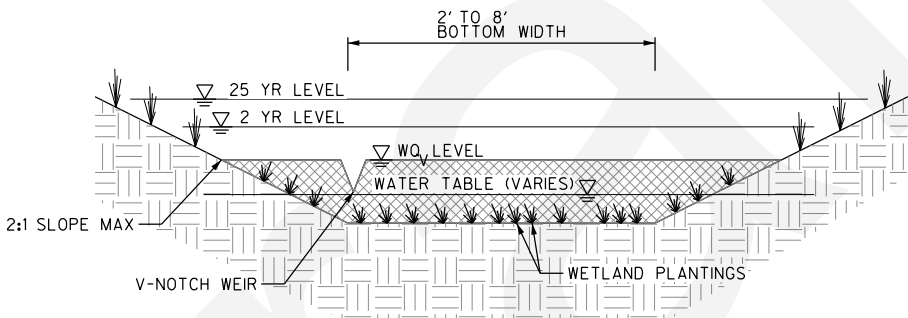

SECTION A-A  
NOT TO SCALE

NOTES:

1. RECOMMENDED WIDTHS OF ENHANCED SWALES IS BETWEEN 2 AND 8 FEET. DIMENSIONS SHALL BE PROVIDED BY DESIGNER IN PLANS AND SHALL BE BASED ON SITE SPECIFIC CONDITIONS. DESIGN PROFESSIONAL SHALL AT A MINIMUM PROVIDE THE FOLLOWING INFORMATION:
  - HORIZONTAL CONTROL
  - VERTICAL CONTROL
  - WATER QUALITY PROTECTION VOLUME
  - STREAMBANK PROTECTION VOLUME
  - FLOOD DISCHARGE
  - PRETREATMENT INFORMATION
  - LANDSCAPING INFORMATION
  - OVERFLOW PATH FOR 25-YR + EVENTS
  - ROCK RIP RAP GRADATION
  - WEIR CALCULATIONS
  - DRAINAGE AGGREGATE INFORMATION
2. DESIGN ENGINEER IS RESPONSIBLE FOR PROVIDING CALCULATIONS THAT DEMONSTRATE THAT SYSTEM AS A WHOLE CAN EFFECTIVELY TREAT THE WATER QUALITY VOLUME (WQv) AS SPECIFIED IN SECTION 1.4 OF THE NCTCOG WATER QUALITY TECHNICAL MANUAL. FLOW IN EXCESS OF THE WQv SHALL BE DESIGNED TO BYPASS THE SYSTEM VIA THE OVERFLOW SYSTEM(S).
3. DESIGN OF THIS SYSTEM SHALL FOLLOW THAT OF SECTION 3 "ENHANCED SWALE" CONTAINED IN THE NCTCOG SITE DEVELOPMENT CONTROLS ISWM TECHNICAL MANUAL.
4. PLEASE NOTE THAT WET SWALE PLACEMENT SHOULD BE CAREFULLY CONSIDERED DUE TO THEIR PROPENSITY TO RETAIN STANDING WATER WHICH PROVIDES A BREEDING GROUND FOR MOSQUITOS AND OTHER DISEASE CARRYING SPECIES.
5. LANDSCAPING SPECIFIED BY DESIGNER SHOULD BE CARFULLY CHOSEN TO ENSURE SURVIVABILITY DURING BOTH SUBMERGED AND DROUGHT EXTREMES.
6. DESIGNER SHALL BE RESPONSIBLE FOR PREPARING AN OPERATIONS AND MAINTENANCE MANUAL OR MATRIX FOR SYSTEMS TO AID OWNER IN DETERMINING MAINTENANCE PROCEDURES AND INTERVALS. DESIGNER SHALL ALSO CONSIDER MAINTENANCE ACCESS WHEN DESIGNING SYSTEM.

FIGURE X.X  
SCHEMATIC OF AN ENHANCED WET SWALE

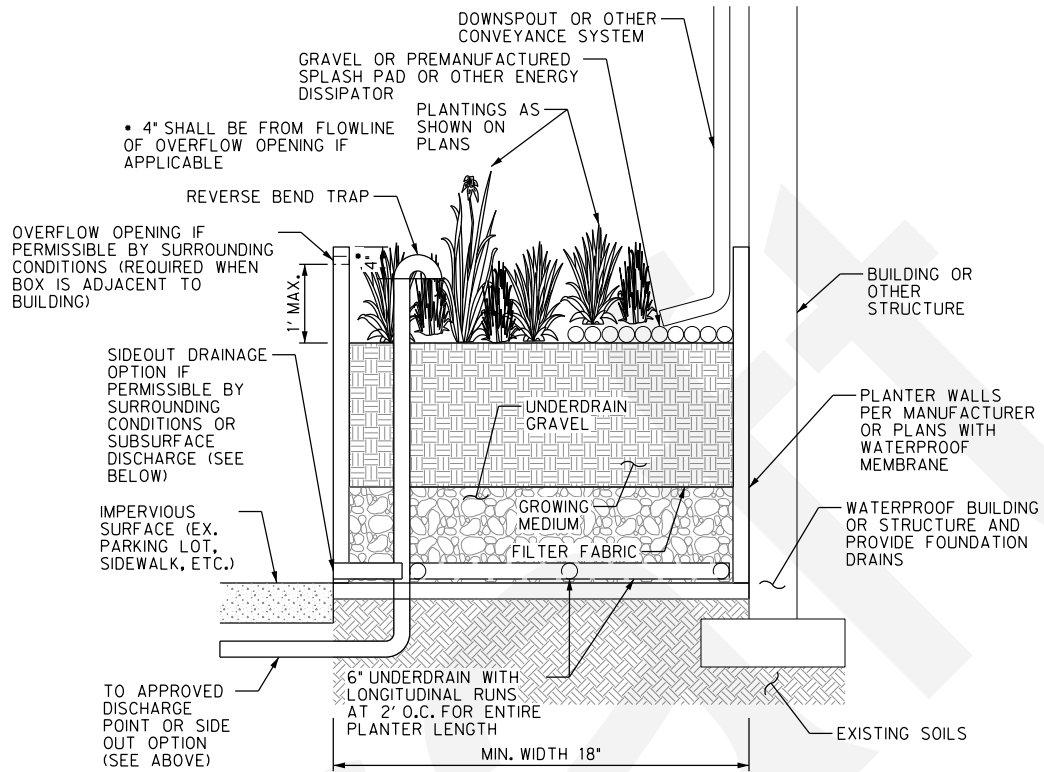

**FLOW-THROUGH PLANTER**  
NOT TO SCALE

**NOTES:**

1. DIMENSIONS SHALL BE PROVIDED BY DESIGNER IN PLANS AND SHALL BE BASED ON SITE SPECIFIC CONDITIONS. DESIGN PROFESSIONAL SHALL AT A MINIMUM PROVIDE THE FOLLOWING INFORMATION:

- HORIZONTAL CONTROL
- VERTICAL CONTROL
- WATER QUALITY PROTECTION VOLUME
- LANDSCAPING INFORMATION
- PLANTER COMPOSITION AND STRUCTURAL INFORMATION (IF REQUIRED)
- WATERPROOFING OR OTHER STRUCTURAL PROTECTIONS
- GROWING MEDIUM INFORMATION
- DRAINAGE AGGREGATE AND UNDERDRAIN INFORMATION

2. DESIGN ENGINEER IS RESPONSIBLE FOR PROVIDING CALCULATIONS THAT DEMONSTRATE THAT GROWING MEDIUM AND SYSTEM AS A WHOLE CAN EFFECTIVELY TREAT THE WATER QUALITY VOLUME (WOV) AS SPECIFIED IN SECTION 1.4 OF THE NCTCOG WATER QUALITY TECHNICAL MANUAL. FLOW IN EXCESS OF THE WOV SHALL BE DESIGNED TO BYPASS THE SYSTEM VIA THE OVERFLOW SYSTEM(S).

3. DESIGN OF THIS SYSTEM SHALL FOLLOW THAT OF SECTION 15 "PLANTER BOXES" CONTAINED IN THE NCTCOG SITE DEVELOPMENT CONTROLS ISWM TECHNICAL MANUAL.

4. LANDSCAPING SPECIFIED BY DESIGNER SHOULD BE CAREFULLY CHOSEN TO ENSURE SURVIVABILITY DURING BOTH SUBMERGED AND DROUGHT EXTREMES.

5. CARE SHOULD BE TAKEN TO ENSURE THAT OVERFLOW PATHS DO NOT CREATE AN UNSAFE CONDITION ON ADJACENT PEDESTRIAN SURFACES.

6. DESIGNER SHALL BE RESPONSIBLE FOR PREPARING AN OPERATIONS AND MAINTENANCE MANUAL OR MATRIX FOR SYSTEMS TO AID OWNER IN DETERMINING MAINTENANCE PROCEDURES AND INTERVALS. DESIGNER SHALL ALSO CONSIDER MAINTENANCE ACCESS WHEN DESIGNING SYSTEM.

**FIGURE X.X**  
**SCHEMATIC OF A FLOW-THROUGH PLANTER BOX**



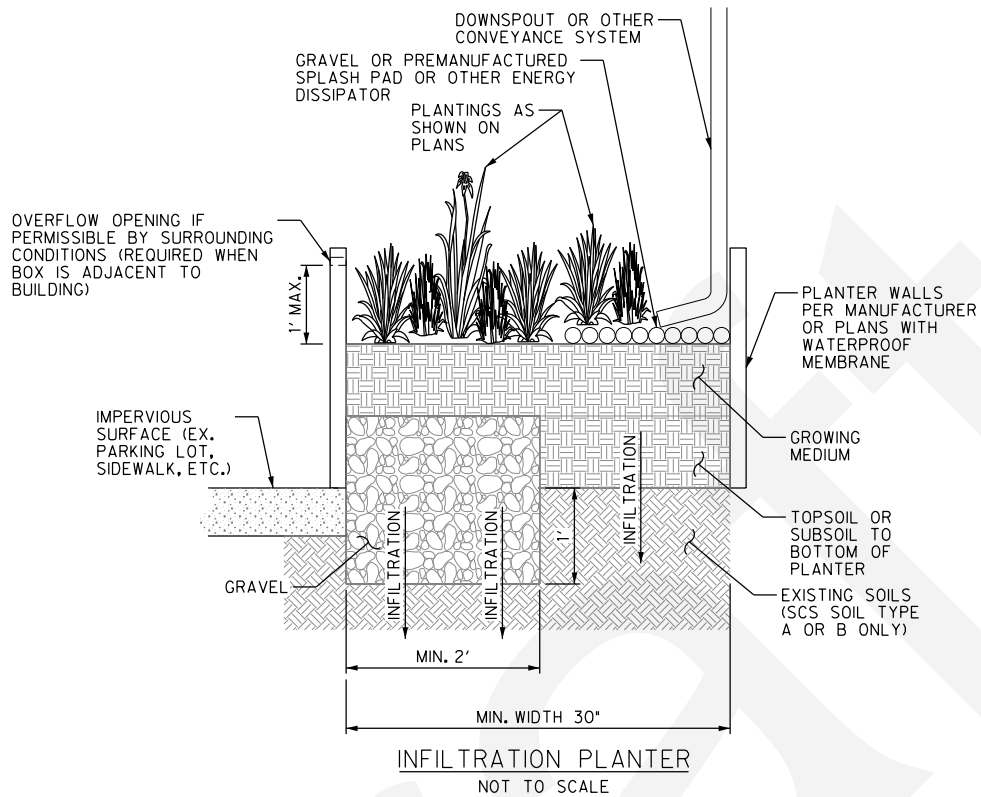

**NOTES:**

1. DIMENSIONS SHALL BE PROVIDED BY DESIGNER IN PLANS AND SHALL BE BASED ON SITE SPECIFIC CONDITIONS. DESIGN PROFESSIONAL SHALL AT A MINIMUM PROVIDE THE FOLLOWING INFORMATION:

- HORIZONTAL CONTROL
- VERTICAL CONTROL
- WATER QUALITY PROTECTION VOLUME
- LANDSCAPING INFORMATION
- PLANTER COMPOSITION AND STRUCTURAL INFORMATION (IF REQUIRED)
- WATERPROOFING OR OTHER STRUCTURAL PROTECTIONS
- GROWING MEDIUM INFORMATION
- DRAINAGE AGGREGATE INFORMATION

2. DESIGN ENGINEER IS RESPONSIBLE FOR PROVIDING CALCULATIONS THAT DEMONSTRATE THAT GROWING MEDIUM AND SYSTEM AS A WHOLE CAN EFFECTIVELY TREAT THE WATER QUALITY VOLUME (WQV) AS SPECIFIED IN SECTION 1.4 OF THE NCTCOG WATER QUALITY TECHNICAL MANUAL. FLOW IN EXCESS OF THE WQV SHALL BE DESIGNED TO BYPASS THE SYSTEM VIA THE OVERFLOW SYSTEMS).

3. DESIGN OF THIS SYSTEM SHALL FOLLOW THAT OF SECTION 15 'PLANTER BOXES' CONTAINED IN THE NCTCOG SITE DEVELOPMENT CONTROLS ISWM TECHNICAL MANUAL.

4. LANDSCAPING SPECIFIED BY DESIGNER SHOULD BE CAREFULLY CHOSEN TO ENSURE SURVIVABILITY DURING BOTH SUBMERGED AND DROUGHT EXTREMES.

5. DESIGNER SHALL ENSURE THAT SYSTEM IS CAPABLE OF BEING FULLY DRAINED WITHIN 48-HOURS.

6. CARE SHOULD BE TAKEN TO ENSURE THAT OVERFLOW PATHS DO NOT CREATE AN UNSAFE CONDITION ON ADJACENT PEDESTRIAN SURFACES.

7. CARE SHOULD BE TAKEN TO ENSURE THAT EXISTING SOILS INTENDED TO FACILITATE INFILTRATION ARE NOT COMPACTED DURING ADJACENT CONSTRUCTION OPERATIONS.

8. DESIGNER SHALL BE RESPONSIBLE FOR PREPARING AN OPERATIONS AND MAINTENANCE MANUAL OR MATRIX FOR SYSTEMS TO AID OWNER IN DETERMINING MAINTENANCE PROCEDURES AND INTERVALS. DESIGNER SHALL ALSO CONSIDER MAINTENANCE ACCESS WHEN DESIGNING SYSTEM.

**FIGURE X.X**  
**SCHEMATIC OF AN INFILTRATION PLANTER BOX**

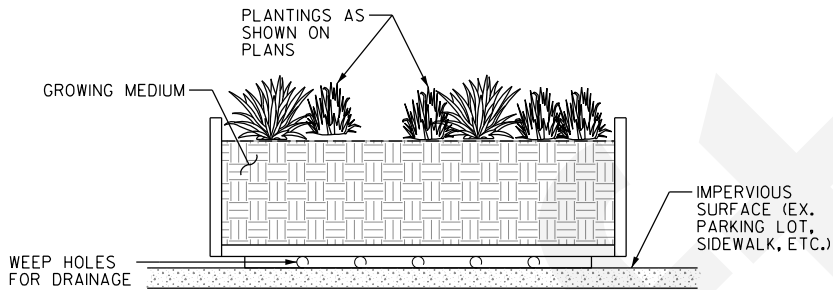

CONTAINED PLANTER  
NOT TO SCALE

**NOTES:**

1. DIMENSIONS SHALL BE PROVIDED BY DESIGNER IN PLANS AND SHALL BE BASED ON SITE SPECIFIC CONDITIONS. DESIGN PROFESSIONAL SHALL AT A MINIMUM PROVIDE THE FOLLOWING INFORMATION:

- HORIZONTAL CONTROL
- VERTICAL CONTROL
- WATER QUALITY PROTECTION VOLUME
- LANDSCAPING INFORMATION
- PLANTER COMPOSITION AND STRUCTURAL INFORMATION (IF REQUIRED)
- GROWING MEDIUM INFORMATION

2. DESIGN ENGINEER IS RESPONSIBLE FOR PROVIDING CALCULATIONS THAT DEMONSTRATE THAT GROWING MEDIUM AND SYSTEM AS A WHOLE CAN EFFECTIVELY TREAT THE WATER QUALITY VOLUME (WQV) AS SPECIFIED IN SECTION 1.4 OF THE NCTCOG WATER QUALITY TECHNICAL MANUAL. FLOW IN EXCESS OF THE WQV SHALL BE DESIGNED TO BYPASS THE SYSTEM VIA THE OVERFLOW SYSTEM(S).

3. DESIGN OF THIS SYSTEM SHALL FOLLOW THAT OF SECTION 15 "PLANTER BOXES" CONTAINED IN THE NCTCOG SITE DEVELOPMENT CONTROLS ISWM TECHNICAL MANUAL.

4. LANDSCAPING SPECIFIED BY DESIGNER SHOULD BE CAREFULLY CHOSEN TO ENSURE SURVIVABILITY DURING BOTH SUBMERGED AND DROUGHT EXTREMES.

5. DESIGNER SHALL ENSURE THAT SYSTEM IS CAPABLE OF BEING FULLY DRAINED WITHIN 48-HOURS.

6. CARE SHOULD BE TAKEN TO ENSURE THAT OVERFLOW PATHS DO NOT CREATE AN UNSAFE CONDITION ON ADJACENT PEDESTRIAN SURFACES.

7. DESIGNER SHALL BE RESPONSIBLE FOR PREPARING AN OPERATIONS AND MAINTENANCE MANUAL OR MATRIX FOR SYSTEMS TO AID OWNER IN DETERMINING MAINTENANCE PROCEDURES AND INTERVALS. DESIGNER SHALL ALSO CONSIDER MAINTENANCE ACCESS WHEN DESIGNING SYSTEM.

**FIGURE X.X**  
**SCHMATIC OF A CONTAINED PLANTER BOX**

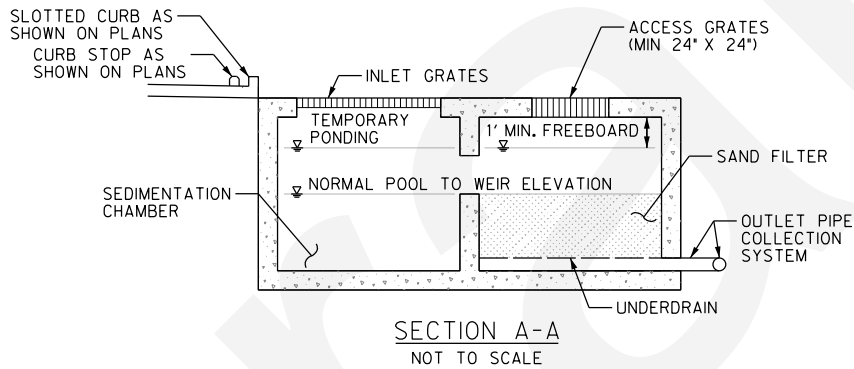
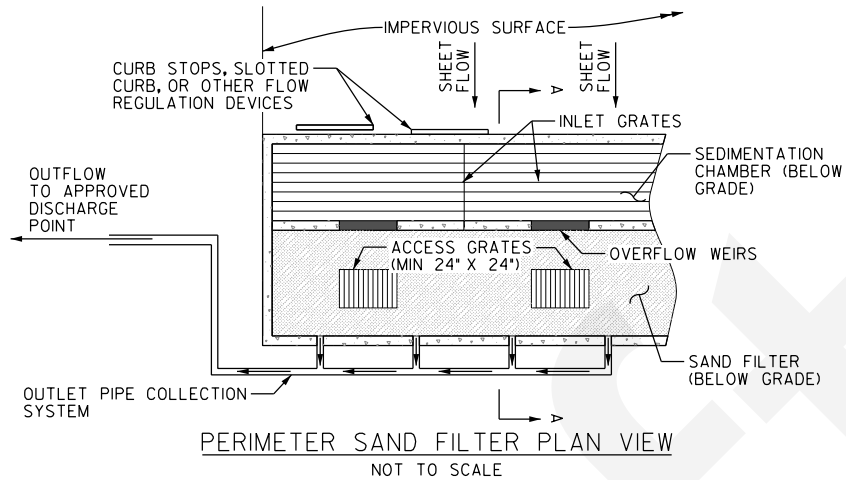

**NOTES:**

1. DIMENSIONS SHALL BE PROVIDED BY DESIGNER IN PLANS AND SHALL BE BASED ON SITE SPECIFIC CONDITIONS. DESIGN PROFESSIONAL SHALL AT A MINIMUM PROVIDE THE FOLLOWING INFORMATION:
  - HORIZONTAL CONTROL
  - VERTICAL CONTROL
  - WATER QUALITY PROTECTION VOLUME
  - STREAMBANK PROTECTION VOLUME
  - FLOOD CONTROL VOLUME
  - CHAMBER STRUCTURAL AND ACCESS INFORMATION
  - OUTLET PIPE INFORMATION
2. DESIGN ENGINEER IS RESPONSIBLE FOR PROVIDING CALCULATIONS THAT DEMONSTRATE THAT SYSTEM AS A WHOLE CAN EFFECTIVELY TREAT THE WATER QUALITY VOLUME (WQV) AS SPECIFIED IN SECTION 1.4 OF THE NCTCOG WATER QUALITY TECHNICAL MANUAL. FLOW IN EXCESS OF THE WQV SHALL BE DESIGNED TO BYPASS THE SYSTEM VIA THE OVERFLOW SYSTEM(S).
3. DESIGN OF THIS SYSTEM SHALL FOLLOW THAT OF SECTION 16 "SAND FILTERS" CONTAINED IN THE NCTCOG SITE DEVELOPMENT CONTROLS ISWM TECHNICAL MANUAL.
4. DESIGNER SHALL BE RESPONSIBLE FOR PREPARING AN OPERATIONS AND MAINTENANCE MANUAL OR MATRIX FOR SYSTEMS TO AID OWNER IN DETERMINING MAINTENANCE PROCEDURES AND INTERVALS. DESIGNER SHALL ALSO CONSIDER MAINTENANCE ACCESS WHEN DESIGNING SYSTEM.

**FIGURE X.X**  
**SCHEMATIC OF A PERIMETER SAND FILTER**

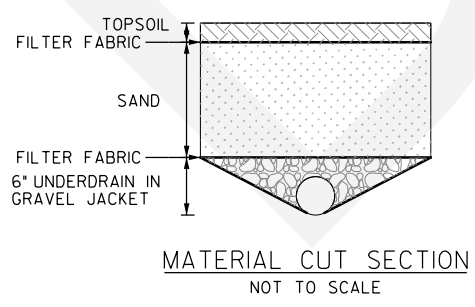
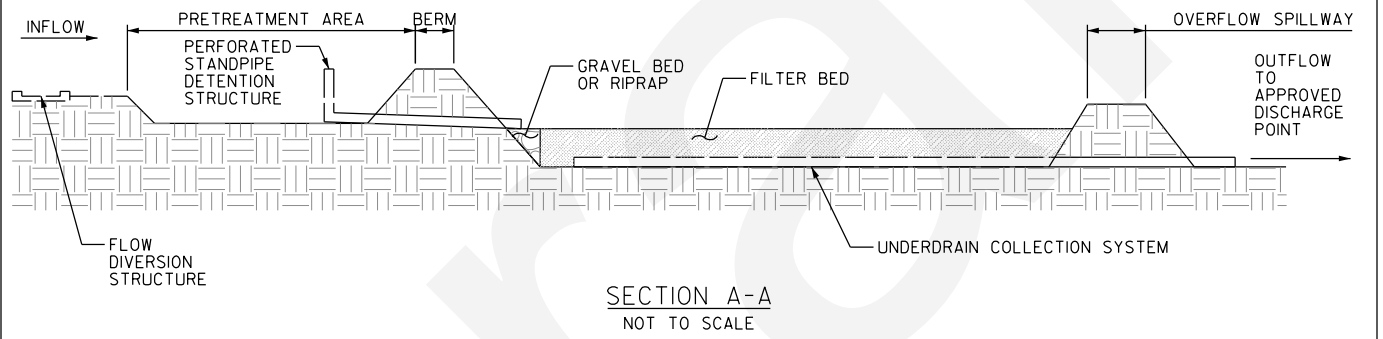
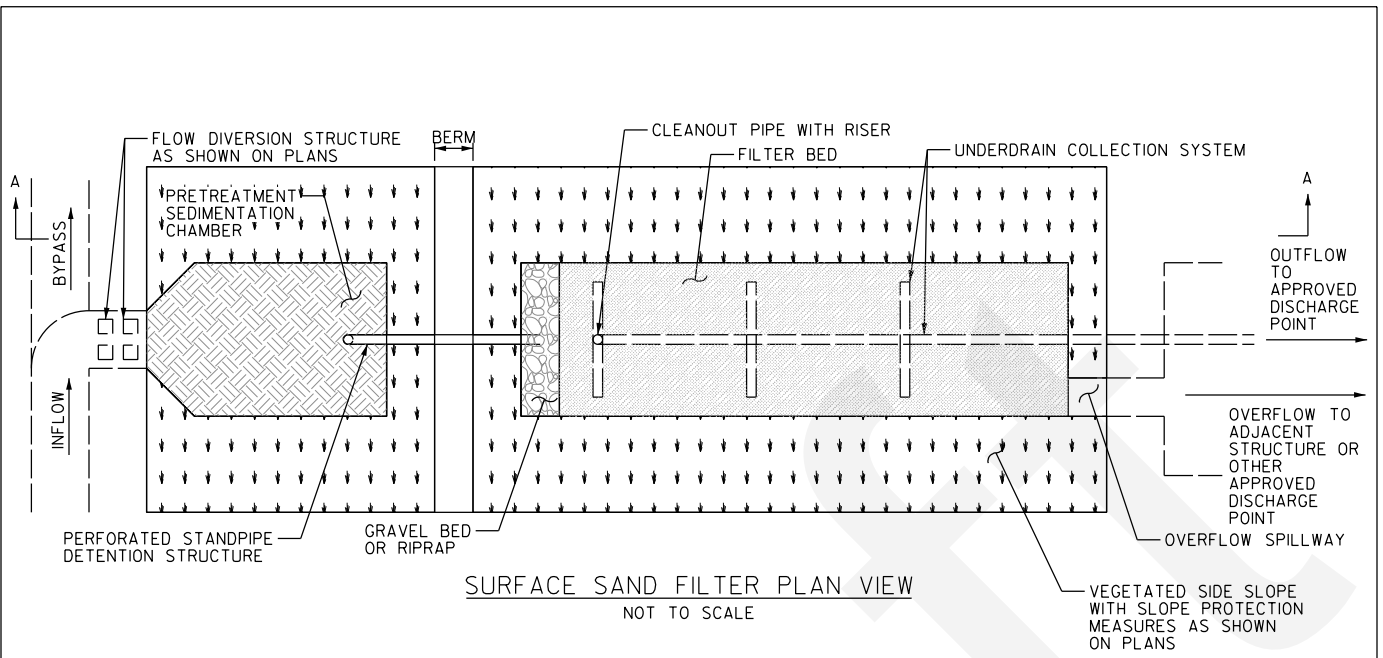

**NOTES:**

1. DIMENSIONS SHALL BE PROVIDED BY DESIGNER IN PLANS AND SHALL BE BASED ON SITE SPECIFIC CONDITIONS. DESIGN PROFESSIONAL SHALL AT A MINIMUM PROVIDE THE FOLLOWING INFORMATION:
  - HORIZONTAL CONTROL
  - VERTICAL CONTROL
  - WATER QUALITY PROTECTION VOLUME
  - STREAMBANK PROTECTION VOLUME
  - FLOOD CONTROL VOLUME
  - RIPRAP INFORMATION
  - FLOW DIVERSION STRUCTURE DETAIL(S)
  - DRAINAGE AGGREGATE AND UNDERDRAIN INFORMATION
2. DESIGN ENGINEER IS RESPONSIBLE FOR PROVIDING CALCULATIONS THAT DEMONSTRATE THAT COMPOSITE MEDIA AND SYSTEM AS A WHOLE CAN EFFECTIVELY TREAT THE WATER QUALITY VOLUME (WQV) AS SPECIFIED IN SECTION 1.4 OF THE NCTCOG WATER QUALITY TECHNICAL MANUAL. FLOW IN EXCESS OF THE WQV SHALL BE DESIGNED TO BYPASS THE SYSTEM VIA THE OVERFLOW SYSTEMS).
3. DESIGN OF THIS SYSTEM SHALL FOLLOW THAT OF SECTION 16 "SAND FILTERS" CONTAINED IN THE NCTCOG SITE DEVELOPMENT CONTROLS ISWM TECHNICAL MANUAL.
4. DESIGNER SHALL ENSURE THAT SYSTEM IS CAPABLE OF BEING FULLY DRAINED WITHIN 48-HOURS.
5. DESIGNER SHALL BE RESPONSIBLE FOR PREPARING AN OPERATIONS AND MAINTENANCE MANUAL OR MATRIX FOR SYSTEMS TO AID OWNER IN DETERMINING MAINTENANCE PROCEDURES AND INTERVALS. DESIGNER SHALL ALSO CONSIDER MAINTENANCE ACCESS WHEN DESIGNING SYSTEM.

**FIGURE X.X**  
**SCHMATIC OF A SURFACE SAND FILTER**

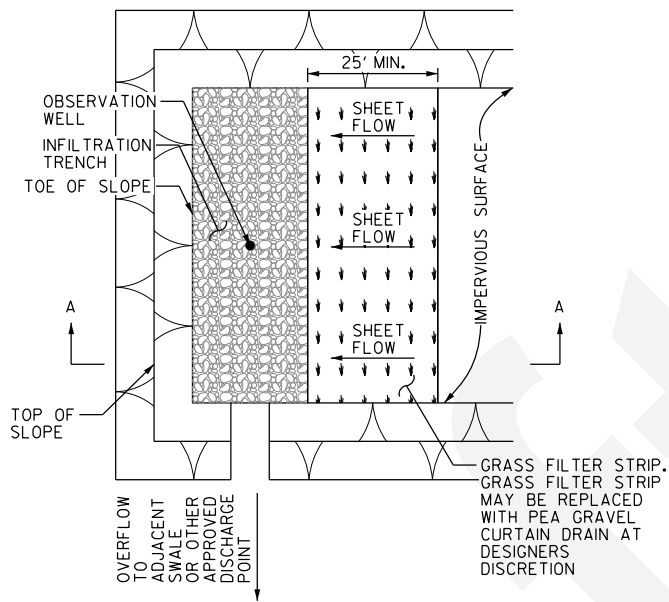

INFILTRATION TRENCH  
NOT TO SCALE

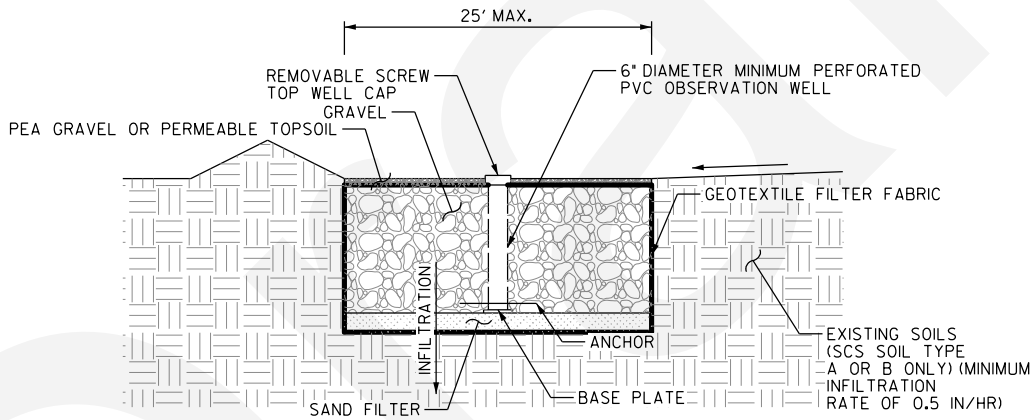

SECTION A-A  
NOT TO SCALE

NOTES:

1. RECOMMENDED MAXIMUM WIDTH OF INFILTRATION TRENCH IS 25- FEET. DIMENSIONS SHALL BE PROVIDED BY DESIGNER IN PLANS AND SHALL BE BASED ON SITE SPECIFIC CONDITIONS. DESIGN PROFESSIONAL SHALL AT A MINIMUM PROVIDE THE FOLLOWING INFORMATION:
  - HORIZONTAL CONTROL
  - VERTICAL CONTROL
  - WATER QUALITY PROTECTION VOLUME
  - STREAMBANK PROTECTION VOLUME (IF NEEDED)
  - OBSERVATION WELL INFORMATION
  - PRETREATMENT INFORMATION
2. DESIGN ENGINEER IS RESPONSIBLE FOR PROVIDING CALCULATIONS THAT DEMONSTRATE THAT GROWING MEDIUM AND SYSTEM AS A WHOLE CAN EFFECTIVELY TREAT THE WATER QUALITY VOLUME (WQV) AS SPECIFIED IN SECTION 1.4 OF THE NCTCOG WATER QUALITY TECHNICAL MANUAL. FLOW IN EXCESS OF THE WQV SHALL BE DESIGNED TO BYPASS THE SYSTEM VIA THE OVERFLOW SYSTEM(S).
3. DESIGN OF THIS SYSTEM SHALL FOLLOW THAT OF SECTION 20 "INFILTRATION TRENCH" CONTAINED IN THE NCTCOG SITE DEVELOPMENT CONTROLS ISWM TECHNICAL MANUAL.
4. DESIGNER SHALL ENSURE THAT SYSTEM IS CAPABLE OF BEING FULLY DRAINED WITHIN 48-HOURS.
5. CARE SHOULD BE TAKEN TO ENSURE THAT EXISTING SOILS INTENDED TO FACILITATE INFILTRATION ARE NOT COMPACTED DURING ADJACENT CONSTRUCTION OPERATIONS.
6. DESIGNER SHALL BE RESPONSIBLE FOR PREPARING AN OPERATIONS AND MAINTENANCE MANUAL OR MATRIX FOR SYSTEMS TO AID OWNER IN DETERMINING MAINTENANCE PROCEDURES AND INTERVALS. DESIGNER SHALL ALSO CONSIDER MAINTENANCE ACCESS WHEN DESIGNING SYSTEM.

FIGURE X.X  
SCHEMATIC OF AN ON-LINE INFILTRATION TRENCH

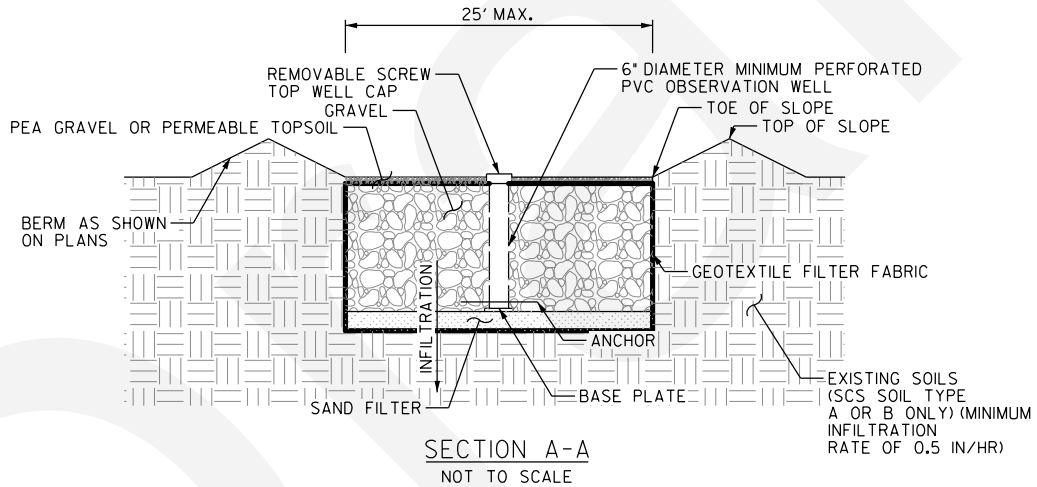
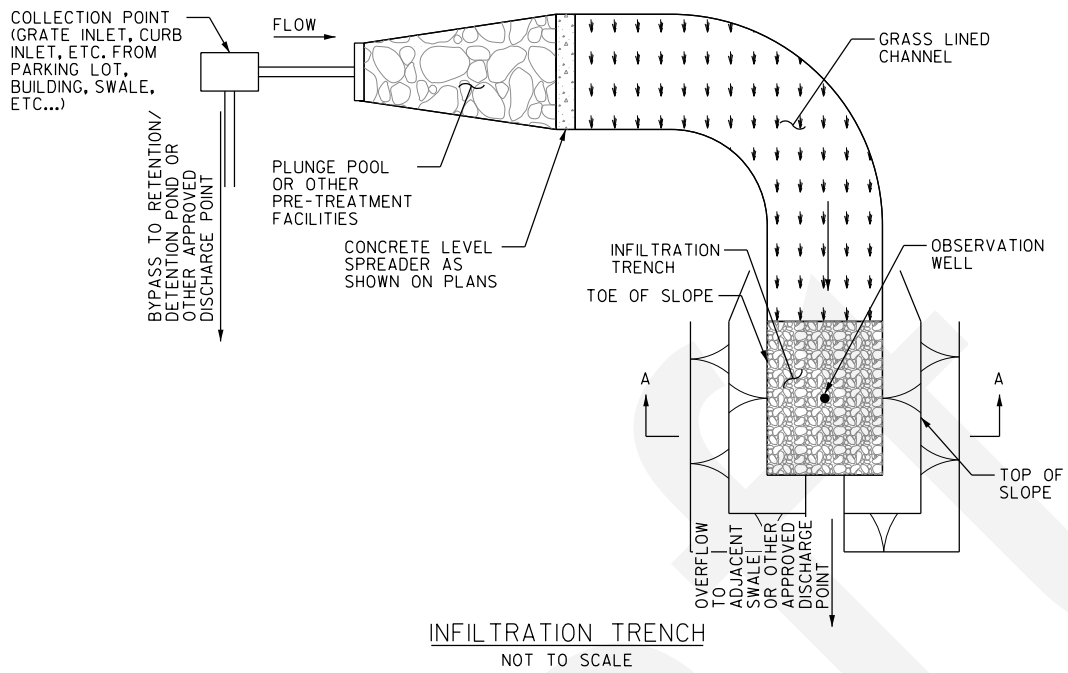

**NOTES:**

1. RECOMMENDED MAXIMUM WIDTH OF INFILTRATION TRENCH IS 25- FEET. DIMENSIONS SHALL BE PROVIDED BY DESIGNER IN PLANS AND SHALL BE BASED ON SITE SPECIFIC CONDITIONS. DESIGN PROFESSIONAL SHALL AT A MINIMUM PROVIDE THE FOLLOWING INFORMATION:
  - HORIZONTAL CONTROL
  - VERTICAL CONTROL
  - WATER QUALITY PROTECTION VOLUME
  - STREAMBANK PROTECTION VOLUME (IF NEEDED)
  - OBSERVATION WELL INFORMATION
  - PRE-TREATMENT INFORMATION
2. DESIGN ENGINEER IS RESPONSIBLE FOR PROVIDING CALCULATIONS THAT DEMONSTRATE THAT GROWING MEDIUM AND SYSTEM AS A WHOLE CAN EFFECTIVELY TREAT THE WATER QUALITY VOLUME (WQV) AS SPECIFIED IN SECTION 1.4 OF THE NCTCOG WATER QUALITY TECHNICAL MANUAL. FLOW IN EXCESS OF THE WQV SHALL BE DESIGNED TO BYPASS THE SYSTEM VIA THE OVERFLOW SYSTEM(S).
3. DESIGN OF THIS SYSTEM SHALL FOLLOW THAT OF SECTION 20 "INFILTRATION TRENCH" CONTAINED IN THE NCTCOG SITE DEVELOPMENT CONTROLS ISWM TECHNICAL MANUAL.
4. DESIGNER SHALL ENSURE THAT SYSTEM IS CAPABLE OF BEING FULLY DRAINED WITHIN 48-HOURS.
5. CARE SHOULD BE TAKEN TO ENSURE THAT EXISTING SOILS INTENDED TO FACILITATE INFILTRATION ARE NOT COMPACTED DURING ADJACENT CONSTRUCTION OPERATIONS.
6. DESIGNER SHALL BE RESPONSIBLE FOR PREPARING AN OPERATIONS AND MAINTENANCE MANUAL OR MATRIX FOR SYSTEMS TO AID OWNER IN DETERMINING MAINTENANCE PROCEDURES AND INTERVALS. DESIGNER SHALL ALSO CONSIDER MAINTENANCE ACCESS WHEN DESIGNING SYSTEM.

**FIGURE X.X**  
**SCHEMATIC OF AN OFF-LINE INFILTRATION TRENCH**